



# Digital Color Doppler Ultrasound System

## ECO 5 Instruction Manual

V3.0

Mar. 1<sup>st</sup>, 2022

57-00329-10

CHISON Medical Technologies Co., Ltd.

We reserve the rights to make changes to this manual without prior notice

## Regulatory Requirement

 0197 This product conforms to the essential requirements of the Medical Device Directive 93/42/EEC. Accessories without the CE mark are not guaranteed to meet the Essential Requirements of the Medical Device Directive.

This manual is a reference for the ECO 5. Please verify that you are using the latest revision of this document. If you need the latest revision, contact your distributor.

### **NOTE:**

#### Important

1. No part of this manual may be reduced, modified, copied or reprinted, in whole or in part, without written permission from CHISON.
2. The contents of this manual are subject to change without prior notice and without our legal obligation.
3. Before operating the system, please read and understand this manual. After reading, keep this manual in an easily accessible place. If you have any question or doubt, please contact CHISON's authorized service engineer.
4. CHISON's Warranty only cover material and parts costs for repair, but do not cover any labor cost or onsite service cost at end user's side.

** NOTE:**

## Important information

1. It is the customer's responsibility to maintain and manage the system after delivery.
2. The warranty does not cover the following items, even during the warranty period:
  - a) Damage or loss due to misuse or abuse with system and probes, for example, drop the probe, the liquid or the metal part fall into the system.
  - b) Damage or loss caused by Acts of God such as fires, earthquakes, floods, lightning, etc.
  - c) Damage or loss caused by failure to meet the specified conditions for this system, such as inadequate power supply, improper installation or environmental conditions.
  - d) Damage or loss caused by non-approved transportation by CHISON.
  - e) Damage or loss due to use the system outside the region where the system was originally sold.
  - f) Damage or loss involving the system purchased from a source other than CHISON or its authorized agents.
3. Do not make changes or modifications to the software or hardware of this system and probes.
4. During operating the system, if user has any doubt, difficulty or any unclear, please contact CHISON's authorized service engineer immediately. Please describe the situation clearly to solve the question in time. Before solve the question, please don't operate the system.
5. This system shall not be used by persons other than fully qualified and certified medical personnel.
6. It is prohibited to use the device for fetal sex examination, except for necessary medical needs. The device can only be sold to qualified medical institutions or doctors. The users shall fully understand and master the devices before operating. The users shall have got the qualification, and shall comply with the local laws and regulations, the local religion and customs, etc.

7. The System modified or repaired by people other than CHISON's qualified service engineers, CHISON shall not be liable for the system.
8. The purpose of this system is to provide physicians with data for clinical diagnosis. It is the physician's responsibility for diagnostic procedures. CHISON shall not be liable for the results of diagnostic procedures
9. This manual contains warnings regarding foreseeable potential dangers, but user shall always be alert to dangers other than those indicated as well. CHISON shall not be liable for damage or loss that results from negligence or from ignoring the precautions and operating instructions described in this operation manual.
10. Due to negligence not following operation manual, CHISON shall not be liable for the results.
11. Each time before and after ultrasound examination, please check the probe surface, probe cable and sheath whether they are abnormal, such as cracking, peeling and deformation. Also check whether the lens is strongly fixed. Abnormal probes may cause electric shock and injure the patient. Once any abnormal, user must stop using and contact CHISON's authorized service engineer.
12. If the probe is dropped or scratched by hard part, please stop using the probe immediately. And contact CHISON's authorized service engineer to make sure the safety and effectiveness is in good condition before use.
13. If there is any liquid or metal to enter to the system, please power off the system and stop using it immediately. Please first contact CHISON's authorized service engineer to make sure it's safe before restart using it.
14. Please don't use solvents (such as paint thinner, benzine, or alcohol) or abrasive cleansers for cleaning the system (including monitor and probes, etc). It may corrode the system and probes.
15. While the system or probe is over life time, please refer to operation manual section 9.4
16. Important data must be backed up on external memory media. CHISON shall not be liable for loss of data stored in the memory of this system caused by operator error or accidents.

17. Please put this operation manual with the system to ensure operator and manager can reach it at any time.

18. LCD display screen may have some dark or light dots, it is normal for the LCD. It does not mean that LCD screen is defective.

 **CAUTION:** *It is prohibited to use the device for fetal sex examination, except for necessary medical needs. The device can only be sold to qualified medical institutions or doctors. The users shall fully understand and master the devices before operating. The users shall have got the qualification, and shall comply with the local laws and regulations, the local religion and customs, etc.*

 **CAUTION:** *The users should read the operation manual carefully before operating the devices. Turning on the device means the users have read the operation manual and accept the listed cautions, warnings, and notes in the manuals. If the users disagree and cannot accept the cautions, the users can ask for returning the device.*

# Content

Chapter 1 Introduction .....	1
<b>1.1 System Overview</b> .....	<b>1</b>
<b>1.2 Contact Information</b> .....	<b>1</b>
Chapter 2 System Safety .....	2
<b>2.1 Safety Overview</b> .....	<b>2</b>
<b>2.2 Electrical Safety</b> .....	<b>3</b>
<b>2.3 Label</b> .....	<b>6</b>
<b>2.4 Patient Environmental Devices</b> .....	<b>8</b>
<b>2.5 Biological Safety</b> .....	<b>10</b>
<b>2.6 Scanning Patients and Education</b> .....	<b>12</b>
<b>2.7 Battery Handling Instructions</b> .....	<b>19</b>
Chapter 3 System Introduction.....	21
<b>3.1 Console View</b> .....	<b>21</b>
<b>3.2 Physical Specification</b> .....	<b>21</b>
<b>3.3 System View in Different Views</b> .....	<b>22</b>
<b>3.4 Function Introduction</b> .....	<b>23</b>
<b>3.5 Installation Procedures</b> .....	<b>25</b>
Chapter 4 Control Panel.....	32
<b>4.1 Alphanumeric Keyboard</b> .....	<b>32</b>
<b>4.2 Function Keys/Knob</b> .....	<b>32</b>
<b>4.3 Central Control</b> .....	<b>34</b>
<b>4.4 The key of Image Mode</b> .....	<b>36</b>
<b>4.5 Control of Image</b> .....	<b>36</b>
Chapter 5 Operation and Exam Mode .....	40
<b>5.1 Preparing the System for Use</b> .....	<b>40</b>
<b>5.2 Choose Exam Mode</b> .....	<b>40</b>
<b>5.3 Patient Data Entry</b> .....	<b>41</b>
<b>5.4 Image Interface Display</b> .....	<b>42</b>
<b>5.5 Display Mode</b> .....	<b>43</b>

5.6 B Image Adjustment .....	47
5.7 B Image Menu Adjustment.....	49
5.8 CFM Image Adjustment .....	52
5.9 PW Image Adjustment.....	53
5.10 Full Screen Show .....	55
5.11 Edit Comment .....	55
5.12 Set Body Mark.....	58
5.13 Set the Direction of Arrow .....	58
5.14 Image and Cine Disposition .....	59
5.15 Image Browse .....	60
5.16 Archive Management .....	61
5.17 Report .....	62
5.18 DICOM.....	64
Chapter 6 Measurement and Calculation .....	66
6.1 Keyboard for Measurement .....	66
6.2 B Mode general Measurement methods.....	67
6.3 B Fast Measurement.....	70
6.4 B General Measurement .....	71
6.5 ABD Measurement .....	72
6.6 OB Measurement.....	73
6.7 Pediatric Measurement.....	76
6.8 GYN Measurement .....	77
6.9 Small Parts Measurement .....	78
6.10 B Mode Vessel Measurement.....	78
6.11 Urology Measurement.....	78
6.12 Cardiac Measurement.....	79
6.13 Normal Measurement in M, B/M mode.....	79
6.14 General Measurement in M mode .....	81
6.15 M Abdomen Measurement.....	81
6.16 M OB Measurement .....	81

6.17 M GYN Measurement.....	81
6.18 M Mode Cardiac Measurement .....	82
6.19 M Urology Measurement .....	83
6.20 M Small Parts Measurement.....	83
6.21 M Pediatric Measurement .....	83
6.22 PW mode measurement methods.....	84
6.23 PW Fast Measurement .....	85
6.24 PW General Measurement .....	85
6.25 PW Abdomen Measurement.....	86
6.26 PW OB Measurement .....	87
6.27 PW GYN Measurement .....	87
6.28 PW Cardiology Measurement .....	88
6.29 PW Vascular Measurement.....	91
6.30 PW Urology Measurement .....	92
6.31 PW Small parts Measurement.....	92
6.32 PW Pediatric Measurement .....	92
Chapter 7 Preset .....	93
7.1 General setting.....	93
7.2 Measurement.....	96
7.3 Comment .....	104
7.4 Body marks.....	107
7.5 Exam Mode .....	108
7.6 Report.....	112
7.7 DICOM .....	115
7.8 NET Work.....	116
7.9 System .....	117
Chapter 8 System Maintenance.....	119
8.1 Machine Cleaning.....	119
8.2 Safety Check.....	119
8.3 Malfunction Check .....	119



Chapter 9 Probes .....	121
<b>9.1 General Description</b> .....	<b>121</b>
<b>9.2 Care and Maintenance</b> .....	<b>121</b>
<b>9.3 Probe Operation Instructions</b> .....	<b>133</b>
<b>9.4 Service Responsibility</b> .....	<b>136</b>
<b>Appendix A: The Information of EC Representative</b> .....	<b>138</b>
<b>Appendix B: Acoustic Output Report Table</b> .....	<b>139</b>
<b>Appendix C: Guidance and Manufacturer’s Declaration</b> .....	<b>180</b>
<b>Appendix D: Measurement Results Summary</b> .....	<b>184</b>
<b>Appendix E: Display Accuracy and Acoustic Measurement Uncertainties</b> .....	<b>185</b>
<b>Appendix F: Transducer Maximum Surface Temperature</b> .....	<b>186</b>
<b>Appendix G: Procedures of setting network sharing</b> .....	<b>187</b>

# Chapter 1 Introduction

This manual contains necessary information for safe system operation.

Read and understand all instructions in this manual before operating the system. Always keeping this manual with the equipment, and periodically review the procedures for operation and safety precautions.

## 1.1 System Overview

### Indications for Use

The device is a general-purpose ultrasonic imaging instrument intended for use by a qualified physician for evaluation of Fetal/OB; Abdominal (GYN & Urology); Pediatric; Small Organ(breast, testes, thyroid); Cardiac (adult & pediatric); Peripheral Vascular; Musculo-skeletal Conventional & Superficial; Transrectal and Transvaginal.

### Contraindication

The system is NOT intended for ophthalmic use or any use that causes the acoustic beam to pass through the eye.

## 1.2 Contact Information

For additional information or assistance, please contact your local distributor or the appropriate support resource shown below:

CHISON website	<a href="http://www.chison.com">www.chison.com</a>
Service Support	CHISON Medical Technologies Co., Ltd. Tel:0086-0510-85311707 Fax: 0086-0510-85310726 E-mail: <a href="mailto:service@chison.com.cn">service@chison.com.cn</a>
Placing an Order	CHISON Medical Technologies Co., Ltd. Tel: 0086-0510-8531-0593/0937 Fax: 0086-0510-85310726 Email: <a href="mailto:export@chison.com.cn">export@chison.com.cn</a>
Manufacturer	CHISON Medical Technologies Co., Ltd. No.3 Changjiang South Road, Xinwu District, Wuxi, 214028 Jiangsu, P.R. China

# Chapter 2 System Safety

## 2.1 Safety Overview

This section discusses measures to ensure the safety of both the operator and patient. To ensure the safety of both operator and patient, please read the relevant details in this chapter carefully before operating this system. **Disregarding the warnings or violation of relevant rules may result in personal injury or even loss of life for operator or patient.**

### Users should observe the following precautions:

- This system complies with Type BF general equipment, and the IEC standard.
- Do not modify this system in any way. Necessary modifications must be made only by the manufacturer or its designated agents.
- This system has been fully adjusted at the factory. Do not adjust any fixed adjustable parts.
- In the event of a malfunction, turn off the system immediately and inform the manufacturer or its designated agents.
- The power cable of the system should only be connected to a grounded power socket. Do not remove the ground cable for any reason.
- Only connect this system, either electronically or mechanically, with devices that comply with the EN60601-1 standard. Recheck the leakage current and other safety performance indices of the entire system to avoid potential system damage caused by leakage from a current superposition.
- The system does not incorporate any specialized protective measures in the event it is configured with high-frequency operation devices. The operator should use caution in these types of applications.
- The system should be installed only by personnel authorized by the manufacturer. Do not attempt to install the system by yourself.
- Only an authorized service engineer may perform maintenance.
- Only a qualified operator, or someone under qualified supervision, should use the system.
- Do not use this system in the presence of flammable substances, otherwise an explosion may occur.

- Do not continuously scan the same part of a patient or expose the patient to prolonged scanning; otherwise it may harm the patient.
- When using the system for ultrasound testing, use only qualified ultrasound gel that complies with system standards.
- Do not unplug probe when the system is in active operation. Always go to EXAM screen when need to remove the probe.
- To prevent from arm or neck injury, the operator should not stay at the same position for too long during patient scanning without taking break.
- Do not put liquid on top of the main unit.

 **NOTE:**

*\*The system has built-in screen saver to avoid the tic mark on the display. It is not recommended to constantly turn on and off the unit.*

*\*To dispose of this product properly, please call your local service department.*

## 2.2 Electrical Safety

### **Type of protection against electric shock**

- **Class I Equipment**

CLASS I EQUIPMENT in which protection against electric shock does not rely on BASIC INSULATION only, but includes a protective earth ground. This additional safety precaution prevents exposed metal parts from becoming LIVE in the event of an insulation failure.

 **NOTE:** *The mains supply shall be cut off after disconnecting the power line and the net power.*

### **Degree of protection against electric shock**

- **Type BF Applied part** (for Probes marked with BF symbol)

TYPE BF APPLIED PART providing a specified degree of protection against electric shock, with particular regard to allowable LEAKAGE CURRENT

### **Level of protection against harmful ingress of water**

- Parts of probe likely to come into contact with operator or patient meet the requirements of

drip-proof equipment (IPX1)

Parts of probe intended to be immersed in normal use meet the requirements of watertight equipment (IPX7)

- The IP Classification of System is Ordinary Equipment (IPX0)

**Safety level when used in the presence of FLAMMABLE ANAESTHETIC MIXED WITH AIR (or WITH OXYGEN or WITH NITROUS OXIDE):**

The Equipment is not suitable for use in the environment with FLAMMABLE ANAESTHETIC MIXED WITH AIR (or WITH OXYGEN or WITH NITROUS OXIDE)

**Mode of operation**

- Continuous Operation

For maximum safety, always follow these guidelines:

- Proper grounding of the system is critical to avoid electrical shock. For protection, ground the chassis with a three-wire cable and plug, and plug the system into a hospital-grade, three-hole outlet.
- Do not remove or circumvent the grounding wire.
- Do not remove the protective covers on the system. These covers protect users from hazardous voltages. Cabinet panels must remain in place while the system is in use. A qualified electronic technician must make all internal replacements.
- Do not operate this system in the presence of flammable gases or anesthetics.
- All peripheral devices (unless certified as medical grade) that are connected to the system must be powered through the electrical outlet through an optional isolation transformer.

**Notice upon Installation of Product**

Separation distance and effect from fixed radio communications equipment: field strengths from fixed transmitters, such as base stations for radio (cellular/cordless) telephones and land mobile radios, amateur radio, AM and FM radio broadcast, and TV broadcast transmitter cannot be predicted theoretically with accuracy. To assess the electromagnetic environment due to fixed RF

transmitters, an electromagnetic site survey should be considered. If the measured field strength in the location in which the ultrasound system is used exceeds the applicable RF compliance level as stated in the immunity declaration, the ultrasound system should be observed to verify normal operation. If abnormal operation is observed, additional measures may be necessary, such as re-orienting or relocating the ultrasound system or using an RF shielded examination room may be necessary.

- Use either power supply cords provided or designated by CHISON. Products equipped with a power source plug should be plugged into the fixed power socket which has the protective grounding conductor. Never use any adaptor or converter to connect with a power source plug (e.g. three-prong-to-two-prong converter).
- Locate the equipment as far away as possible from other electronic equipment.
- Be sure to use only the cables provided by or designated by CHISON. Connect these cables following the installation procedures (e.g. wire power cables separately from signal cables).
- Lay out the main equipment and other peripherals following the installation procedures described in this manual.

### **Notice against User Modification**

The user should never modify this product.

User modifications may cause degradation in Electrical Safety. Modification of the product includes changes in:

- Cables (length, material, wiring, etc.)
- System configuration/components

User modifications may cause degradation in EMC performance. Modification of the product includes changes in:



- Cables (length, material, wiring, etc.)
- System installation/layout
- System configuration/components
- Securing system parts (cover open/close, cover screwing)

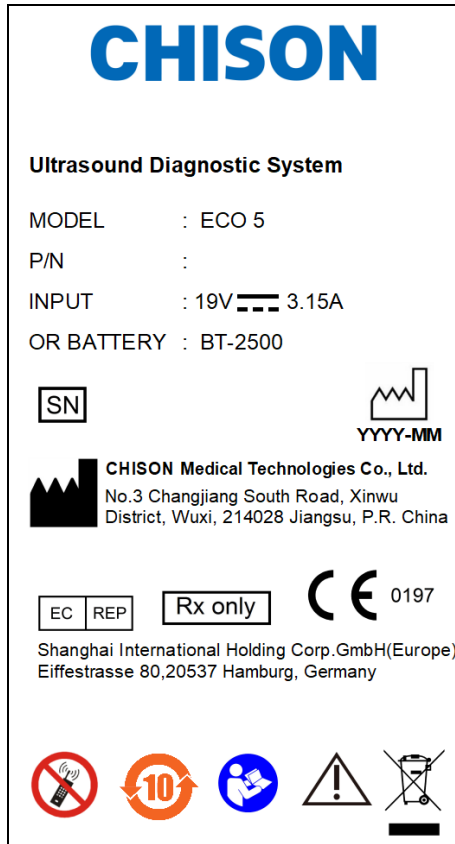









## 2.3 Label



Real panel label

### 2.3.1 Warning Symbols

 <p>This mark indicates that this product contains a limited amount of hazardous substances in the Chinese Standard GB/T 26572-2011 "Limited Requirements for Restricted Substances in Electrical and Electronic Products". The numbers in the logo are the environmental protection use period of the product, indicating that under the normal use conditions, the harmful substances will not leak or be abrupt. The use of the product will not cause serious pollution to the environment or cause personal or property serious damage, the term unit is year</p>	 <p><b>WASTE OF ELECTRICAL AND ELECTRONIC EQUIPMENT (WEEE):</b> This symbol is used for Environment Protection, it indicates that the waste of electrical and electronic equipment must not be disposed as unsorted waste and must be collected separately. Please contact your local Authority or distributor of the manufacturer for information concerning the decommissioning of your equipment.</p>
---	---

 <p>Do not use the following devices near this equipment: cellular phone, radio receiver, and mobile radio transmitter, radio controlled toy, etc. Use of these devices near this equipment could cause this equipment to perform outside the published specifications. Keep power to these devices turned off when near this equipment.</p>	 <p>Caution, consult accompanying documents. This symbol advises the reader to consult the accompanying documents for important safety related information such as warnings and pre-cautions that cannot be presented on the device itself.</p>
 <p>This symbol signifies that the user manual must be read.</p>	 <p>The CE mark of Conformity indicates this equipment conforms with the Council Directive 93/42/EEC.</p>
 <p>AUTHORIZED REPRESENTATIVE IN THE EUROPEAN COMMUNITY: This symbol is accompanied by the name and the address of the authorized representative in the European Community.</p>	 <p>Type-BF applied part.</p>
 <p>This symbol is followed by the serial number of the device.</p>	 <p>MANUFACTURER: This symbol is accompanied by the name and the address of the manufacturer.</p>
 <p>Direct current To indicate on the rating plate that the equipment is suitable for direct current only; to identify relevant terminals.</p>	<p><b>Rx only</b> This symbol indicates that in the united states of America, Federal law restricts the device to sale by or on the order of a licensed practitioner or therapist.</p>
 <p>This symbol is followed by the manufacturing date of the device in the form YYYY-MM.</p>	 <p><b>CORRECT:</b> The correct connection of the battery connector. <b>WRONG:</b> The wrong connection of the battery connector.</p>



## 2.4 Patient Environmental Devices

### Left side:

- ◆ 1 LAN port
- ◆ 1 VGA port: External monitor
- ◆ 2 USB ports
- ◆ 1 Footswitch port
- ◆ 1 Power in port

### Rear panel:

- ◆ 2 Probe ports
- ◆ 1 USB port
- ◆ 1 Video out port
- ◆ 1 Remote port

### Acceptable Devices

The Patient Environmental devices shown above are specified to be suitable for use within the PATIENT ENVIRONMENT.

#### **CAUTION:**

- *DO NOT connect any probes or accessories without approval by CHISON within the PATIENT ENVIRONMENT.*
- *DO NOT touch patient and devices without IEC/EN 60601-1 approval to avoid the leakage current risk within the PATIENT ENVIRONMENT.*

### Unapproved Devices

#### **CAUTION:**

- *DO NOT use unapproved devices.*
- *If devices are connected without the approval of CHISON, the warranty will be INVALID.*
- *The system can't be used with HF surgical equipment; otherwise the burns to patient may occur.*

Any device connected to this system must conform to one or more of the requirements listed

below:

- IEC standard or equivalent standards appropriate to devices.
- The devices shall be connected to PROTECTIVE EARTH (GROUND).

 **CAUTION:**

*Unsafe operation or malfunction may result. Use only the accessories, options and supplies approved or recommended in these instructions for use.*

### **Peripheral used in the patient environment**

The system has been verified for overall safety, compatibility and compliance with the following on-board image recording devices:

B/W video printer: SONY UP-X898MD

The system may also be used safely while connected to devices other than those recommended above if the devices and their specifications, installation, and interconnection with the system conform to the requirements of IEC/EN 60601-1.

Adapter is considered as a part of ME equipment

The connection of equipment or transmission networks other than as specified in the user instructions can result in an electric shock hazard or equipment malfunction. Substitute or alternate equipment and connections require verification of compatibility and conformity to IEC/EN 60601-1 by the installer. Equipment modifications and possible resulting malfunctions and electromagnetic interference are the responsibility of the owner.

General precautions for installing an alternate off-board, remote device or a network would include:

- The added device(s) must have appropriate safety standard conformance and CE Marking.
- There must be adequate mechanical mounting of the device and stability of the combination.
- Risk and leakage current of the combination must comply with IEC/EN 60601-1.
- Electromagnetic emissions and immunity of the combination must conform to IEC/EN 60601-1-2.

### **Peripheral used in the non-patient environment**

The system has been verified for compatibility, and compliance for connection to a local area network (LAN) via a wire LAN, provided the LAN components are IEC/EN 60601-1 compliant.

General precautions for installing an alternate off-board, remote device or a network would include:

- The added device(s) must have appropriate safety standard conformance and CE Marking.
- The added device(s) must be used for their intended purpose having a compatible interface.

**⚠ CAUTION:** *Make sure using ONLY the dedicated USB disk or removable media to save or back up data. Before connecting to the ultrasound system, make sure using the latest antivirus software on the USB disk or removable media to clean any virus. It is user's responsibility to ensure the USB disk or removable media is virus-free. Improper use of USB disk or removable media may cause the virus infections of system and eventually malfunction may occur. Such malfunction may impact the stability, effectiveness and safety of the system and probes, and users should immediately stop using the system and probes until CHISON authorized engineer has checked the system and confirm the effectiveness and safety of the system and probes.*

**⚠ CAUTION:** *Use only secure Local Area Network connection. Don't connect the ultrasound system to Internet. Make sure your hospital's firewall software is configured correctly, thus blocking incoming connection requests from Internet. Improper use of network connection may cause the virus infections of system and eventually malfunction may occur.*

## 2.5 Biological Safety

This product, as with all diagnostic ultrasound equipment, should be used only for valid reasons and should be used both for the shortest period of time and at the lowest power settings necessary (ALARA - As Low As Reasonably Achievable) to produce diagnostically acceptable images. The AIUM offers the following guidelines:

*Clinical Safety Quoted from AIUM*

*Approved March 26, 1997*

*Diagnostic ultrasound has been in use since the late 1950s. Given its known benefits and recognized efficacy for medical diagnosis, including use during human pregnancy, the American Institute of Ultrasound in Medicine herein addresses the clinical safety of such use:*

*There are no confirmed biological effects on patients or instrument operators caused by exposures from present diagnostic ultrasound instruments. Although the possibility exists that such biological effects may be identified in the future, current data indicate that the benefits to patients of the prudent use of diagnostic ultrasound outweigh the risks, if any that may be present.*

Heating: Elevating tissue temperature during obstetrical examinations creates medical concerns.

At the embryo development stage, the rise in temperature and the length of time exposed to heat combine to determine potential detrimental effects. Exercise caution particularly during Doppler/Color exams. The Thermal Index (TI) provides a statistical estimate of the potential temperature elevation (in centigrade) of tissue temperature. Three forms of TI are available: Soft Tissue Thermal Index (TIS), Bone Thermal Index (TIB) and Cranial Bone Thermal Index (TIC).

Soft Tissue Thermal Index (TIS). Used when imaging soft tissue only, it provides an estimate of potential temperature increase in soft tissue.

Bone Thermal Index (TIB). Used when bone is near the focus of the image as in the third trimester OB examination, it provides an estimate of potential temperature increase in the bone or adjacent soft tissue.

Cranial Bone Thermal Index (TIC). Used when bone is near the skin surface as in transcranial examination, it provides an estimate of potential temperature increase in the bone or adjacent soft tissue.

Cavitations: Cavitations may occur when sound passes through an area that contains a cavity, such as a gas bubble or air pocket (in the lung or intestine, for example). During the process of cavitations, the sound wave may cause the bubble to contract or resonate. This oscillation may cause the bubbles to explode and damage the tissue. The Mechanical Index (MI) has been created to help users accurately evaluate the likelihood of cavitations and the related adverse effects.

MI recognizes the importance of non-thermal processes, cavitations in particular, and the Index is an attempt to indicate the probability that they might occur within the tissue.

## 2.6 Scanning Patients and Education

The Track-3 or IEC60601-2-37 output display standard allows users to share the responsibility for the safe use of this ultrasound system. Follow these usage guidelines for safe operation:

- In order to maintain proper cleanliness of the probes, always clean them between patients.
- Always use a disinfected sheath on all EV/ER probes during every exam.
- Continuously move the probe, rather than staying in a single spot, to avoid elevated temperatures in one part of the patient's body.
- Move probe away from the patient when not actively scanning.
- Understand the meaning of the TI, TIS, TIB, TIC and MI output display, as well as the relationship between these parameters and the thermal/cavitation bioeffect to the tissue.
- Expose the patient to only the very lowest practical transmit power levels for the shortest possible time to achieve a satisfactory diagnosis (ALARA - As Low As Reasonably Achievable).

### 2.6.1 Safe Scanning Guidelines

- Ultrasound should only be used for medical diagnosis and only by trained medical personnel.
- Diagnostic ultrasound procedures should be done only by personnel fully trained in the use of the equipment, in the interpretation of the results and images, and in the safe use of ultrasound (including education as to potential hazards).
- Operators should understand the likely influence of the machine controls, the operating mode (e.g. B mode) and probe frequency on thermal and cavitation hazards.
- Select a low setting for each new patient. Output should only be increased during the examination if penetration is still required to achieve a satisfactory result, and after the Gain control has been moved to its maximum value.

- Maintain the shortest examination time necessary to produce a useful diagnostic result.
  - Do not hold the probe in a fixed position for any longer than is necessary. The frozen frame and Cine loop capabilities allow images to be reviewed and discussed without exposing the patient to continuous scanning.
  - Do not use endo-cavitary probes if there is noticeable self heating of the probe when operating in the air. Although applicable to any probe, take particular care during trans- vaginal exams during the first eight weeks of gestation.
  - Take particular care to reduce output and minimize exposure time of an embryo or fetus when the temperature of the mother is already elevated.
  - Take particular care to reduce the risk of thermal hazard during diagnostic ultrasound when exposing: an embryo less than eight weeks after gestation; or the head, brain or spine of any fetus or neonate.
  - Operators should continually monitor the on-screen thermal index (TI) and mechanical index (MI) values and use control settings that keep these settings as low as possible while still achieving diagnostically useful results. In obstetric examinations, TIS (soft tissue thermal index) should be monitored during scans carried out in the first eight weeks after gestation, and TIB (bone thermal index) thereafter. In applications where the probe is very close to bone (e.g. trans-cranial applications), TIC (cranial bone thermal index) should be monitored.
- MI > 0.3 there is a possibility of minor damage to neonatal lung or intestine. If such exposure is necessary, reduce the exposure time as much as possible.
- MI > 0.7 there is a risk of cavitations if an ultrasound contrast agent containing gas micro-spheres is being used. There is a theoretical risk of cavitations without the presence of ultrasound contrast agents. The risk increases with MI values above this threshold.

TI > 0.7 the overall exposure time of an embryo or fetus should be restricted in accordance with Table 2-2 below as a reference:

TI	Maximum exposure time (minutes)
0.7	60
1.0	30
1.5	15
2.0	4
2.5	1

Maximum recommended exposure times for an embryo or fetus

- Non-diagnostic use of ultrasound equipment is not generally recommended. Examples of non-diagnostic uses of ultrasound equipment include repeated scans for operator training, equipment demonstration using normal subjects, and the production of souvenir pictures or videos of a fetus. For equipment of which the safety indices are displayed over their full range of values, the TI should always be less than 0.5 and the MI should always be less than 0.3. Avoid frequent repeated exposure of any subject. Scans in the first trimester of pregnancy should not be carried out for the sole purpose of producing souvenir videos or photographs, nor should their production involve increasing the exposure levels or extending the scan times beyond those needed for clinical purposes.

- Diagnostic ultrasound has the potential for both false positive and false negative results. Misdiagnosis is far more dangerous than any effect that might result from the ultrasound exposure. Therefore, diagnostic ultrasound system should be performed only by those with sufficient training and education.

## 2.6.2 Understanding the MI/TI Display

Track-3 follows the Output Display Standard for systems that include fetal Doppler applications. The acoustic output will not be evaluated on an application-specific basis, but the global maximum de-rated  $I_{spta}$  must be  $\leq 720 \text{ mW/cm}^2$  and either the global maximum MI must be  $\leq 1.9$  or the global maximum de-rated  $I_{sppa}$  must be  $\leq 190 \text{ W/cm}^2$ . An exception is for ophthalmic use, in

which case the  $TI = \max(TIS_{as}, TIC)$  is not to exceed 1.0;  $Ispta.3 \leq 50mW/cm^2$ , and  $MI \leq 0.23$ . Track-3 gives the user the freedom to increase the output acoustic power for a specific exam, and still limit output acoustic power within the global maximum de-rated  $Ispta \leq 720 mW/cm^2$  under an Output Display Standard.

For any diagnostic ultrasonic systems, Track-3 provides an Output Indices Display Standard. The diagnostic ultrasound systems and its operation manual contain the information regarding an ALARA (As Low As Reasonably Achievable) education program for the clinical end-user and the acoustic output indices, MI and TI. The MI describes the likelihood of cavitations, and the TI offers the predicted maximum temperature rise in tissue as a result of the diagnostic examination. In general, a temperature increase of  $2.5^{\circ}C$  must be present consistently at one spot for 2 hours to cause fetal abnormalities. Avoiding a local temperature rise above  $1^{\circ}C$  should ensure that no thermally induced biologic effect occurs. When referring to the TI for potential thermal effect, a TI equal to 1 does not mean the temperature will rise 1 degree C. It only means an increased potential for thermal effects can be expected as the TI increases. A high index does not mean that bioeffects are occurring, but only that the potential exists and there is no consideration in the TI for the scan duration, so minimizing the overall scan time will reduce the potential for effects. These operator control and display features shift the safety responsibility from the manufacturer to the user. So it is very important to have the Ultrasound systems display the acoustic output indices correctly and the education of the user to interpret the value appropriately.

RF: (De-rating factor)

In Situ intensity and pressure cannot currently be measured. Therefore, the acoustic power measurement is normally done in the water tank, and when soft tissue replaces water along the ultrasound path, a decrease in intensity is expected. The fractional reduction in intensity caused by attenuation is denoted by the de-rating factor (RF),

$$RF = 10^{-0.1 a f z}$$

Where  $a$  is the attenuation coefficient in  $dB\ cm^{-1}\ MHz^{-1}$ ,  $f$  is the transducer center frequency, and  $z$  is the distance along the beam axis between the source and the point of interest.



De-rating factor RF for the various distances and frequencies with attenuation coefficient 0.3dB cm<sup>-1</sup> MHz<sup>-1</sup> in homogeneous soft tissue is listed in the following table. An example is if the user uses 7.5MHz frequency, the power will be attenuated by .0750 at 5cm, or 0.3x7.5x5=-11.25dB. The De- rated Intensity is also referred to as '.3' at the end (e.g. Ispta.3).

Distance (cm)	Frequency (MHz)			
	1	3	5	7.5
1	0.9332	0.8128	0.7080	0.5957
2	0.8710	0.6607	0.5012	0.3548
3	0.8128	0.5370	0.3548	0.2113
4	0.7586	0.4365	0.2512	0.1259
5	0.7080	0.3548	0.1778	0.0750
6	0.6607	0.2884	0.1259	0.0447
7	0.6166	0.2344	0.0891	0.0266
8	0.5754	0.1903	0.0631	0.0158

$I' = I * RF$  Where I' is the intensity in soft tissue, I is the time-averaged intensity measured in water.

Tissue Model:

Tissue temperature elevation depends on power, tissue type, beam width, and scanning mode. Six models are developed to mimic possible clinical situations.

	Thermal Models	Composition	Mode	Specification	Application
1	TIS	Soft tissue	Unscanned	Large aperture (>1cm <sup>2</sup> )	Liver PW
2	TIS	Soft tissue	Unscanned	Small aperture (<1cm <sup>2</sup> )	Pencil Probe
3	TIS	Soft tissue	Scanned	Evaluated at surface	Breast color
4	TIB	Soft tissue and bone	Scanned	Soft tissue at surface	Muscle color
5	TIB	Soft tissue and bone	Unscanned	Bone at focus	Fetus head PW
6	TIC	Soft tissue and bone	Unscanned/scanned	Bone at surface	Transcranial

Soft tissue:

Describes low fat content tissue that does not contain calcifications or large gas-filled spaces.

Scanned: (auto-scan)

Refers to the steering of successive burst through the field of view, e.g. B and color mode.

Unscanned:

Emission of ultrasonic pulses occurs along a single line of sight and is unchanged until the transducer is moved to a new position. For instance, the PW, and M mode.

TI:

TI is defined as the ratio of the In Situ acoustic power ( $W_3$ ) to the acoustic power required to raise tissue temperature by  $1^\circ\text{C}$  ( $W_{deg}$ ),  $TI = W_3/W_{deg}$ .

Three TIs corresponding to soft tissue (TIS) for abdominal; bone (TIB) for fetal and neonatal cephalic; and cranial bone (TIC) for pediatric and adult cephalic, have been developed for applications in different exams.

An estimate of the acoustic power in milli-watts necessary to produce a  $1^\circ\text{C}$  temperature elevation in soft tissue is:

$W_{deg} = 210/f_c$ , for model 1 to 4, where  $f_c$  is the center frequency in MHz.

$W_{deg} = 40 K D^2$  for model 5 and 6, where  $K$  (beam shape factor) is 1.0,  $D$  is the aperture diameter in cm at the depth of interest.

MI:

Cavitation is more likely to occur at high pressures and low frequencies in pulse ultrasound wave in the tissue, which contains the bubble or air pocket (for instance, the lung, intestine, or scan with gas contrast agents). The threshold under optimum conditions of pulsed ultrasound is predicted by the ration of the peak pressure to the square root of the frequency.

$$MI = Pr' / \text{sqrt}(f_c)$$

$Pr'$  is the de-rated (0.3) peak rare-fractional pressure in Mpa at the point where PII is the maximum, and  $f_c$  is the center frequency in MHz. PII is the Pulse Intensity Integral that the total energy per unit area carried by the wave during the time duration of the pulse. The peak rare- fractional pressure is measured in hydrophone maximum negative voltage normalized by the hydrophone calibration parameter.

Display Guideline:

For different operation modes, different indices must be displayed. However, only one index needs to be shown at a time. Display is not required if maximum MI is less than 1.0 for any setting of the operating mode, or if maximum TI is less than 1.0 for any setting of the operating mode. For TI, if the TIS and TIB are both greater than 1.0, the scanners need not be capable of displaying both indices simultaneously. If the index falls below 0.4, no display is needed. The display increments are no greater than 0.2 for index value less than one and no greater than 1.0 for index values greater than one (e.g. 0.4, 0.6, 0.8, 1, 2, and 3).

#### Display and Report

Located on the upper middle section of the system display monitor, the acoustic output display provides the operator with real-time indication of acoustic levels being generated by the system.

#### For Scan

Only display and report MI, and start from 0.4 if maximum MI > 1.0, display in increments of 0.2.

Below is a simple guideline for the user when TI exceeds one limit exposure time to 4(6-TI) minutes based on the 'National Council on Radiation Protection. Exposure Criteria for Medical Diagnostic Ultrasound: I. Criteria Based on Thermal Mechanisms. Report No.113 1992'.

#### Operator Control Features:

The user should be aware that certain operator controls may affect the acoustic output. It is recommended to use the default (or lowest) output power setting and compensate using Gain control to acquire an image. Other than the output power setting in the soft-menu, which has the most direct impact on the power; the PRF, image sector size, frame rate, depth, and focal position also slightly affect the output power. The default setting is normally around 70% of the allowable power depending on the exam application mode.

#### Controls Affecting Acoustic Output

The potential for producing mechanical bioeffects (MI) or thermal bioeffects (TI) can be influenced by certain controls.

Direct: The Acoustic Output control has the most significant effect on Acoustic Output.

Indirect: Indirect effects may occur when adjusting controls. Controls that can influence MI and TI

are detailed under the bioeffect portion of each control in the Optimizing the Image chapter.

Always observe the Acoustic Output display for possible effects.

Best practices while scanning

HINTS: Raise the Acoustic Output only after attempting image optimization with controls that have no effect on Acoustic Output, such as Gain and STC.

 **WARNING:** *Be sure to have read and understood control explanations for each mode used before attempting to adjust the Acoustic Output control or any control that can affect Acoustic Output.*

Use the minimum necessary acoustic output to get the best diagnostic image or measurement during an examination. Begin the exam with the probe that provides an optimum focal depth and penetration.

#### Acoustic Output Default Levels

In order to assure that an exam does not start at a high output level, the system initiates scanning at a reduced default output level. This reduced level is preset programmable and depends upon the exam icon and probe selected. It takes effect when the system is powered on or New Patient is selected. To modify acoustic output, adjust the Power Output level on the Soft Menu.

## 2.7 Battery Handling Instructions

 **CAUTION:** *Read and observe the following warnings and precautions to ensure correct and safe use of Li-ion batteries.*

- Do not immerse the battery in water or allow it to get wet.
- Do not use or store the battery near sources of heat such as a fire or heater.
- Do not use any chargers other than those recommended.
- Do not reverse the positive (+) and negative (-) terminals.
- Do not connect the battery directly to wall outlets or car cigarette-lighter sockets.
- Do not put the battery into a fire or apply direct heat to it.
- Do not short-circuit the battery by connecting wires or other metal objects to the positive (+) and negative (-) terminals.

- Do not pierce the battery casing with a nail or other sharp object, break it open with a hammer, or step on it.
- Do not strike, throw or subject the battery to sever physical shock.
- Do not directly solder the battery terminals.
- Do not attempt to disassemble or modify the battery in any way.
- Do not place the battery in a microwave oven or pressurized container.
- Do not use the battery in combination with primary batteries (such as dry-cell batteries) or batteries of different capacity, type or brand.
- Do not use the battery if it gives off an odor, generates heat, becomes discolored or deformed, or appears abnormal in any way. If the battery is in use or being recharged, remove it from the device or charger immediately and discontinue use.
- Do not use or store the battery where is exposed to extremely hot, such as under window of a car in direct sunlight in a hot day. Otherwise, the battery may be overheated. This can also reduce battery performance and/or shorten service life.
- If the battery leaks and electrolyte gets in your eyes, do not rub them. Instead, rinse them with clean running water and immediately seek medical attention. If left as is, electrolyte can cause eye injury.

## Chapter 3 System Introduction

### 3.1 Console View



Fig. 3-1 Console View

### 3.2 Physical Specification

Dimensions of main unit (approx.): 335mm (Length) ×155mm (Width) ×350mm (Height)

Net weight of main unit (approx.): 6.5kg

### 3.3 System View in Different Views

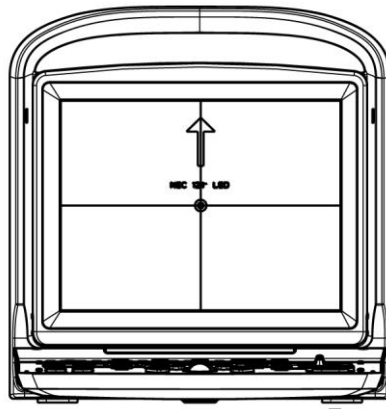

Fig. 3-2 System Front View

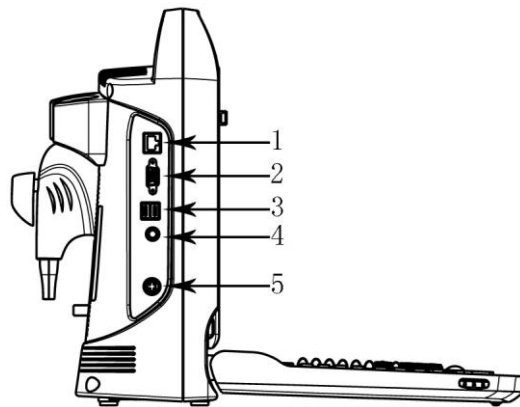

Fig. 3-3 System Side View

1. Ethernet 2. VGA 3.USB 4.FOOT SWITCH 5.DC IN

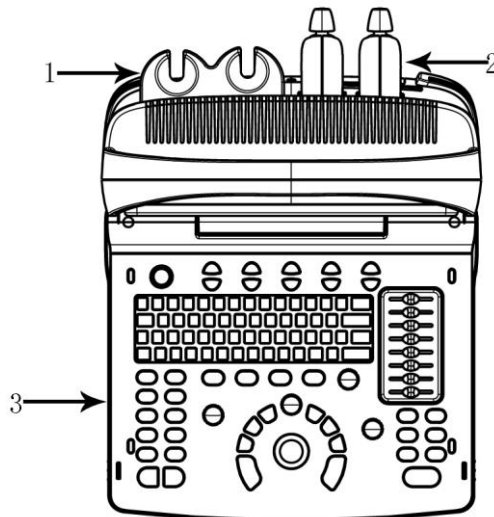

Fig. 3-4 Console Overview

1. Probe Holder 2.Probe 3.Keyboard

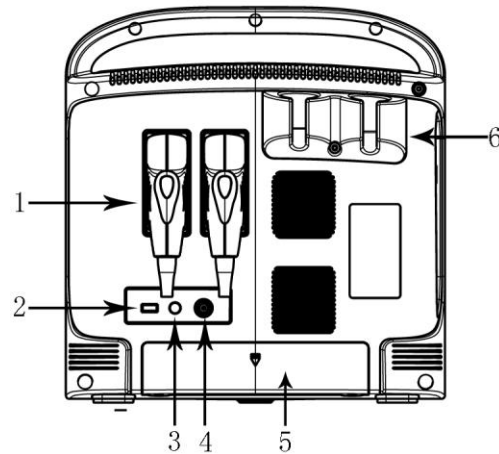

Fig. 3-5 System Rear View

1. Probe 2.USB 3. REMOTE 4. VIDEO OUT 5.Battery Holder 6. Probe Holder

### 3.4 Function Introduction

1. Possess B, 2B, 4B, B/M, M,CFM,PW display mode, M, B/M mode possess 4 kinds of scan velocity;
2. Possess many combination of focus, total gain control 8 segments STC;
3. Possess depth scan and image left-right up-down rolling-over function;
4. Possess a lot of imaging technology for example multiple compound imaging (space frequency compound), multiple frequency, multiple zoom ratio, pan zoom, screen scroll, chroma, harmonic imaging etc.;
5. Possess image processing, total gain, dynamic range, frequency, focus number, focus position, zoom, compound, scan width, line density, smooth, edge enhancement, frame, persistence, gray scale, restrain boost multi-beam, acoustic power, M velocity;
6. Possess distance proportion circumference volume rate angle histogram in B mode distance time velocity heart rate measurement function in M mode ;GYN measurement software package, small parts measurement software package, ventricle function measurement software package and user defined formula;
7. Possess body mark arrow case number display, real time clock display annotation in image user-defined annotation;
8. Possess multi-language interface display User interface change, shear plate, printing ,DICOM 3.0 biopsy guided functions;
9. It has permanent storage for image and cine and optional 320GB HDD minimum. It can also be



connected to removable storage via USB port. To realize mass storage ,can recall saved image for analysis;



10. Cine loop storage 256frames real time image;
- 11.Screen rotation function make you adjust screen angle according to users' requirement 0~30°;
12. Output standard PAL or NTSC video signal and VGA signal;
13. Print or export graphic report.

### 3.4.1 Image Modes

- B mode
- B/M mode
- M mode
- 2B mode
- 4B mode
- CFM mode
- PW mode

### 3.4.2 Accessories

#### Transducers:

	C3-A, 2.5-5.0MHz Convex Array
	L7M-A, 5.3-10.0MHz Linear Array
	L7S-A, 5.3-11.0MHz Linear Array
	V6-A, 4.5-8.0MHz Micro-convex Array
	MC3-A, 2.5-5.0MHz Micro-convex Array
	MC6-A, 4.5-8.0MHz Micro-convex Array

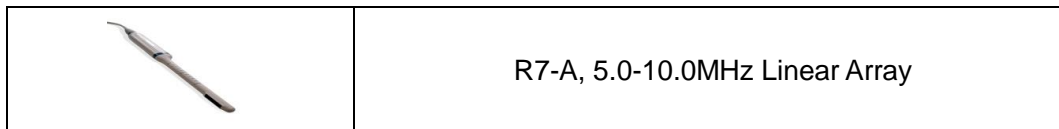

## **Peripherals**

VGA output for external monitor

VIDEO output for B&W video printer

LAN port output

LAN for DICOM and image review station

USB 2.0 for flash drive

Foot switch

AC/DC adapter: MDS-060AAS19 B

Input: 100-250V~1.5-0.75A, 50-60Hz

Output: 19V $\equiv$ 3.15A

DELTA ELECTRONICS, INC.

Battery Pack: BT-2500, 4400mAh, DONGGUAN POWER INC

## **3.5 Installation Procedures**

**⚠ NOTE:** Please do not turn on the power switch until finishing all the installation and necessary preparation.

### **3.5.1 Environment Condition**

The system should be operated under the following environment.

#### **3.5.1.1 Operation Environment Requirement**

Ambient Temperature: 10 °C~40 °C

Relative Humidity: 30%~75%RH

Atmospheric Pressure: 700hPa~1060hPa

Strong radiation sources or powerful electromagnetic waves (e.g. electro-magnetic waves from radio broadcasting) may result in image ghosting or noise. The system should be isolated from such radiation sources or electromagnetic waves.

To prevent damage to the system, do not use in the following locations:

- Exposed to direct sunlight
- Subject to sudden changes in temperature
- Dusty
- Subject to vibration
- Near heat generators
- High humidity

 **NOTE:**

*This equipment generates, uses and can radiate radio frequency energy. The equipment may cause radio frequency interference to other medical and non-medical devices and radio communications. To provide reasonable protection against such interference, this product complies with emissions limits for a Group 1, Class A Medical Devices Directive as stated in EN 60601-1-2. However, there is no guarantee that interference will not occur in a particular installation.*

If this equipment is found to cause interference (which may be determined by turning the equipment on and off), the user (or qualified service personnel) should attempt to correct the problem by one or more of the following measure(s):

- Reorient or relocate the affected device(s).
- Increase the separation between the equipment and the affected device.
- Power the equipment from a source different from that of the affected device.
- Consult the point of purchase or service representative for further suggestions.

### **3.5.1.2 Transport and Storage Environmental Requirement**

The following environmental transport and storage conditions are within system tolerances:

Temperature: -5° C ~ 40° C

Relative Humidity: ≤ 80% non-condensing

Atmosphere Pressure: 700hPa ~ 1060hPa

### **3.5.1.3 Electrical Requirements**

**Power Consumption:** less than 60 VA

**Voltage Fluctuation**

 **WARNING:**

Maintain a fluctuation range of less than  $\pm 10\%$  of voltage labeling on rear panel of the system, otherwise the system may be damaged.

## Grounding

Before connecting the power cable, connect the attached ground protection cable from Equipotentiality terminal on system rear panel to a specialized grounding device.

### **NOTE:**

- Please follow the outlined power requirements. Only use power cables that meet the system guidelines—failure to follow these procedures may produce system damage.
- Line power may vary in different geographic locations. Refer to the detailed ratings on the rear panel of the system for detailed information.

- **Battery**

To avoid the battery bursting, igniting, or fumes from the battery; causing equipment damage, observe the following precautions: Do not immerse the battery in water or allow it to get wet. Do not put the battery into a microwave oven or pressurized container. If the battery leaks or emits an odor, remove it from all possible flammable sources. If the battery emits an odor or heat, is deformed or discolored, or in a way appears abnormal during use, recharging or storage, immediately remove it and stop using it. If you have any questions about the battery, short term (less than one month) storage of battery pack: Store the battery in a temperature range between 0 degrees C (32 degrees F) and 50 degrees C (122 degrees F).

Long term (3 months or more) storage of battery pack: Store the battery in a temperature range between -20 degrees C (-4 degrees F) and 45 degrees C (113 degrees F); Upon receipt of the ECO and before first time usage, it is highly recommended that the customer performs one full discharge/charge cycle. If the battery has not been used for >2 months, the customer is recommended to perform one full discharge/charge cycle. It is also recommended to store the battery in a shady and cool area with FCC (full current capacity).• One Full Discharge/Charge Cycle Process:1. Full discharge of battery to let the ECO automatically shut down.2. Charge the ECO to 100% FCC (full current capacity).3. Discharge of Venue 40 for complete shutdown(takes one hour for discharge).• When storing packs for more than 6 months, charge the pack at least once during the 6 month timeframe to prevent leakage and deterioration in performance.

### 3.5.1.4 Operation Space

Please leave enough free space from the back of the system to ensure well ventilation.

 **CAUTION:** *Leave enough free space from the back of the system; otherwise, with the increasing of the temperature inside the unit, malfunction may occur.*

### 3.5.1.5 System Positioning & Transporting

#### Moving the System

When moving or transporting the system, take the precautions described below to ensure maximum safety for personnel, the system and other equipment.

#### Before Moving the System

- Press  3 s, system will forced shut down and completely switch off the system.
- Disconnect all cables from off-board peripheral devices (external printer, etc.) from the console.

#### **NOTE:**

- *To prevent damage to the power cord, DO NOT pull excessively on the cord or sharply bend the cord while wrapping it.*
- *Store all probes in their original cases or wrap them in soft cloth or foam to prevent damage.*
- *Replace gel and other essential accessories in the appropriate storage case.*
- *Ensure that no loose items are left on the console.*

#### When Moving the System

- Carry the system with handle, or put the system on the cart to move it.

#### **NOTE:**

*Walk slowly and carefully when moving the system.*

*Do not let the system strike walls or doorframe.*

#### Transporting the System

Use extra care when transporting the system in a vehicle. After preparing the system as described above, take the following additional precautions:

- Only use vehicles that are suitable for transport of the system.
- Before transporting, place the system in its original storage carton.

- Load and unload the system to a vehicle parked on a level surface.
- Load the unit aboard the vehicle carefully and over its center of gravity. Keep the unit still and upright.
- Ensure that the transporting vehicle can bear the weight of system plus the passengers.
- Secure the system firmly with straps or as directed within the vehicle to prevent movement during transport. Any movement, coupled with the weight of the system, could cause it to break loose.
- Drive carefully to prevent damage from vibration. Avoid unpaved roads, excessive speeds, and erratic stops or starts.

## 3.5.2 Powering the System

### 3.5.2.1 Acclimation Time

After being transported, the unit requires one hour for each 2.5 ° increment if its temperature is below 10 °C or above 40 °C.

#### **NOTE:**

*Please keep at least 20 to 30 cm spare space away from the back of the system to ensure well ventilation. Otherwise, with the increasing of the temperature inside the unit, malfunction may occur.*

### 3.5.2.2 Connecting the electric power

After making sure that the AC power supply in hospital is in normal status, and this AC voltage type matches to the power requirements indicated on the label of system, then please connect the plug of power cord to the DC IN socket at the rear panel of the system, and connect the other end of power cord to the AC power supply socket in hospital.

Please use the power cable provided by the manufacturer, other type of power cable is not allowed.

Press  1 s, system boot,

Press  and pop up dialog for shut down. Click the enter key then power off.

Or press  3 s, system will forced shut down

 **CAUTION:**

Connecting the system to the wrong AC power supply may cause damage to the system and danger to the operators and animals.

### 3.5.3 Probe Installation

 **CAUTION:** Please only use the probes provided by manufacturer for this model, other types of probes are not allowed to use with this system! Otherwise it may cause the damage to the system and the probe.

 **CAUTION:**

Before connecting the probe, please carefully check the probe lens, probe cable and probe connector to see whether there is anything abnormal, such as cracks, falls off. Abnormal probe is not allowed to connect to the system; otherwise there is possibility of electricity shock.

- Hold the probe connector lock switch, and insert the connector socket vertically.
- Release the probe lock switch.
- Check the locked probe with one hand to make sure that it's not loose, and it's securely connected

 **CAUTION:**

- Only power supply at “turn off” state, can install / take-down the probe, otherwise it will damage the machine or the probe.
- When installing and disassembling probe, please put the probe head inside the probe holder, it can prevent the probe falling down to the ground.

#### 3.5.3.1 Probe Disassembly

Turn the dead lock switch 90degree in counterclockwise direction, extract probe connector plug vertically.

### 3.5.4 Accessories Installation

 **CAUTION:** Please only use the optional parts provided or suggested by manufacturer! Using other types of optional devices may cause the damage to the system and the connected optional devices.

### 3.5.4.1 Video printer installation

1. Put video printer stably.
2. Connect cable of video printer to video port in the back of the device. And connect the other side to video signal output port in the rear side.
3. Connect the printer line to print control port in the printer rear side, and connect the other side to the print control port in the unit rear side.
4. Connect power cable of video printer to power system.
5. Adjust printer parameter preset according to the type of printing paper

**⚠ CAUTION:** Do not use any other power cable to replace 3-wire power cable manufacturer provides, otherwise there is a danger of electric shock.

### Video printer sign introduction

 : Video signal input port

 : Video signal output port

 : Print control port

 : Video printer switch

### 3.5.4.2 Graphic printer installation

Put graphic printer stably, connect printer cable to USB port in the left side of the unit.  
Connect the power cable of graphic printer to power system.

**⚠ CAUTION:** Please see packing list for fundamental configuration!



# Chapter 4 Control Panel

## 4.1 Alphanumeric Keyboard

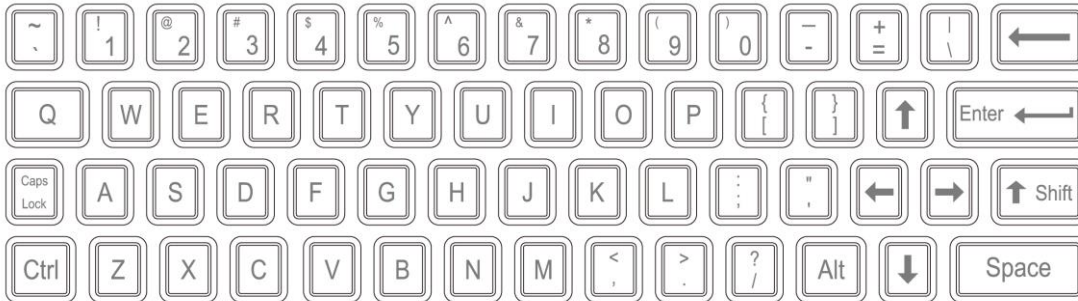

Fig. 4-1 Alphanumeric Keyboard

The alphanumeric keys are used for inputting patient number, name, character and figure etc.

## 4.2 Function Keys/Knob

### 4.2.1 SWITCH



Turn on or off the device

### 4.2.2 PATIENT



Set up a new patient data, input name and other information.

### 4.2.3 PROBE



Press this key for selecting probe. It can only select the connected probe.

### 4.2.4 SETUP



Press this key to get in or out the system setting page.

#### 4.2.5 END



Press END key to finish the exam.

#### 4.2.6 BODYMARK



Press this key to enter into body mark working status, select the body mark and confirm the probe scanning position on the screen. It is only available in frozen status.

#### 4.2.7 COMMENT



Press this key to enter into comment status, and add comments in the image area on the screen.

#### 4.2.8 ARROW



Add arrows icon to the image area.

#### 4.2.9 DEL



Press this key to clear the measurement lines, body mark, and comments.

#### 4.2.10 Print



PRINT1: Print the screen image by video printer connected to the system.

PRINT2: Print the report by printer connected to the system (Only report page works). Or print the image in the scanning page; Or print the image in the review page.

### 4.2.11 Review



File management of system, you can view and edit the patient data.

### 4.2.12 Report



Produce/ Save/ Recall an examination report.

### 4.2.13 Parameter Control Key

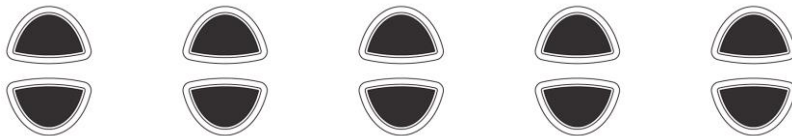

Increase/decrease the corresponding parameters of the screen, or open/close the function.

## 4.3 Central Control

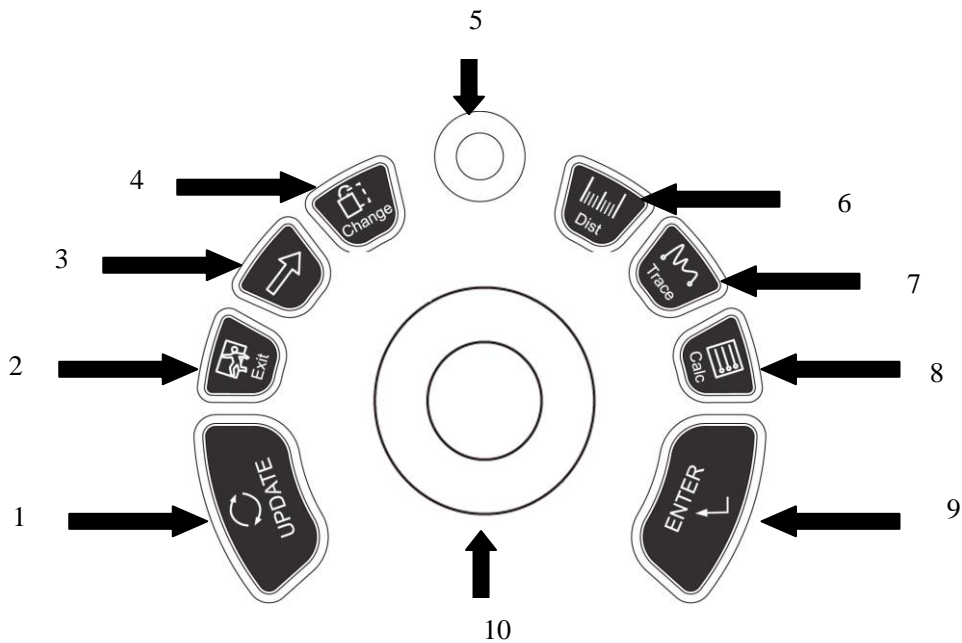

- 1. UPDATE 2.EXIT 3.Cursor 4.Change 5.MENU
- 6. Dist 7.Trace 8.Calc 9.ENTER 10.Trackball

### **4.3.1 ENTER**

This multifunction key is work with trackball. The function switches with the unit status. Such as, set the cursor position, body mark position, comment position, toggle trackball function, selected the menu, and confirm the input.

### **4.3.2 UPDATE**

This multifunction key is work with trackball. The function switches with the unit status. Such as, call the annotation and back in measuring.

### **4.3.3 Exit**

Press this key can exit measurement, dialog, and menu.

### **4.3.4 Cursor**

Press this key to show or hide the cursor.

### **4.3.5 Change**

Press this key to change the menu.

### **4.3.6 Dist**

Press this key to enter into distance measurement.

### **4.3.7 Trace**

Press this key to enter into trace measurement, and press [**UPDATE**] to change between trace and ellipse.

### **4.3.8 Calc**

Press this key to enter into measurement software package.

### **4.3.9 MENU**

Press MENU-knob for second time to select the item and adjust the parameters. Press MENU-knob for third time to exit from current item. Rotate the MENU- knob to select the item.

### **4.3.10 Trackball**

Trackball is the main operation tool on screen. Position calipers in measurement, the function of

the trackball is different under diverse working status.

## 4.4 The key of Image Mode

### 4.4.1 B



Display B mode

### 4.4.2 C



Display CFM mode

### 4.4.3 D



Display PW mode

### 4.4.4 M



Press this key to change the mode between B/M and M.

## 4.5 Control of Image

### 4.5.1 THI



Press this key to open or close the THI function.

### 4.5.2 AIO



Only press this key for automatic optimization image.

### 4.5.3 CINE



Only press this key to save the current cine loop.

### 4.5.4 SAVE



Only press this key to save the current image.

### 4.5.5 Left and Right Invert



Press this key to invert the image from left and right.

### 4.5.6 Up and Down Invert



Press this key to invert the image from up and down.

### 4.5.7 STC

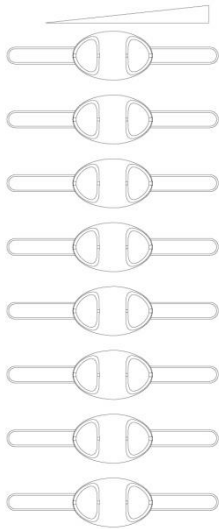

STC can be used for adjusting gain compensation in different image depth.

#### 4.5.8 GAIN

Rotate the knob to adjust the gain of B mode and M mode.

#### 4.5.9 ANGLE/ZOOM Knob

Rotate the knob to adjust the angle or zoom. Press this knob to change the function between angle and zoom.

#### 4.5.10 DEPTH/FOCUS Knob

Press the knob to adjust the depth and function position. Press the knob to change the function between depth and focus position.

#### 4.5.11 Information Area Indicating Machine Status



Left-to-Right of the up row: hard disk, cable network, USB.

- Hard disk: press this icon to show the capacity of disc to used save data or USB flash disk in current system
- Cable network: show the present situation of cable network; press this icon to show the IP address of current system.
- USB: show whether this system connects USB flash disk or not, press this icon to show USB safely remove interface.

Left-to-Right of the down row: Case, Task Sequence, battery gauge.

- Case: press this icon to change case.
- Task Sequence: press this icon to show task and its situation, to terminate the task, delete, and so on.
- Battery gauge: show the connecting situation of the battery, just press this icon to show the present State of charge and discharge, remaining electric quantity and available time.

#### 4.5.12 Indicator Light



From left to right: Adapter Indicator, Charge Indicator, and Sleep Indicator.

- Adapter Indicator: when the main unit connects to the adapter with power supply, the indicator lights, otherwise extinguishes.
- Charge Indicator: When the battery is charging, the indicator lights, once the battery is charged, the indicator goes out.
- Sleep Indicator: When the main unit is in sleep mode, the indicator lights, otherwise extinguished.



# Chapter 5 Operation and Exam Mode

This chapter mainly describes the process of the normal operation of the device, including the preparation before examination, how to get the image, optimize the image, add comments, body mark and so on.

## 5.1 Preparing the System for Use

### 5.1.1 The Device Inspection

1. The device is placed stability;
2. The grid voltage AC 100-250V, 50Hz-60Hz;
3. Cable is properly connected, firm and ground, the adapter is properly connected to the device;
4. Probe is connected and fixed.

### 5.1.2 Power On

Long press  1 second to start the machine, wait for the system to enter the user interface, activate the probe slot into the B mode.

## 5.2 Choose Exam Mode

### 5.2.1 The Probe Identification

The system default automatically identifies the current probe type, when the probe is inserted,

Press  to switch the probe.

**⚠ CAUTION:** Please connect or disconnect the probe only after the system is freezing, in order to ensure stability and extend the service life of the probe.

### 5.2.2 Mode Selection

In probe selection interface, probe and clinical application selection page is displayed, you can choose needed probe and inspection part, and press the default into the B mode, start scan detection.

**NOTE:** The system has been set clinical application pre-set before leaving factory, each probe has its own pre-set.

The detailed operation steps of the clinical application pre-set of the probe, please refer to the pre-set section.

## 5.3 Patient Data Entry

Press the  to display the Patient screen

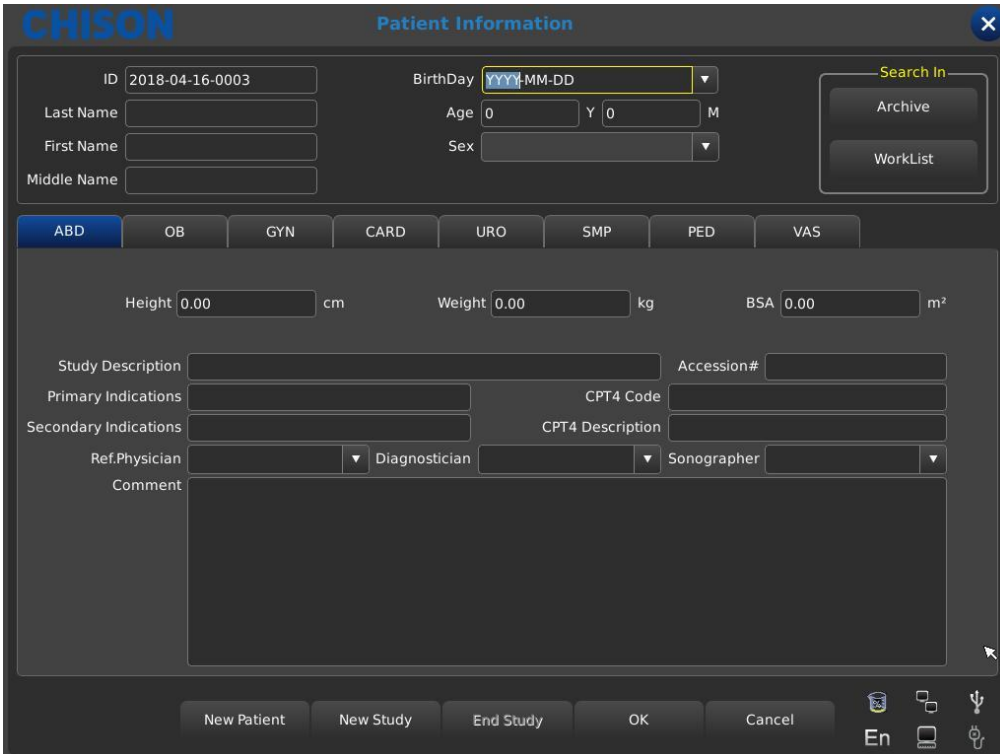

The screenshot shows the 'Patient Information' screen in the CHISON system. The interface includes a header with the CHISON logo and a close button. Below the header, there are several input fields for patient data: ID (2018-04-16-0003), BirthDay (YYYY-MM-DD), Last Name, First Name, Middle Name, Age (0 Y 0 M), and Sex. There are also buttons for 'Search In', 'Archive', and 'WorkList'. A horizontal menu below these fields allows selecting an exam application: ABD, OB, GYN, CARD, URO, SMP, PED, and VAS. Below the menu, there are input fields for Height (0.00 cm), Weight (0.00 kg), and BSA (0.00 m<sup>2</sup>). Further down, there are fields for Study Description, Accession#, Primary Indications, CPT4 Code, Secondary Indications, CPT4 Description, Ref.Physician, Diagnostician, and Sonographer. A large text area is provided for a Comment. At the bottom, there are buttons for 'New Patient', 'New Study', 'End Study', 'OK', and 'Cancel', along with some system icons.

- **Function Buttons** on Patient screen:
- **Archive:** Operation on the patient information which has already existed;
- **Worklist:** Recall patient information in worklist. And need to open the DICOM function;
- **New Patient:** Create a new patient information identity;
- **New Study:** Choose exam applications (OB、GYN、CARD and so on) for the new patient;
- **End Study:** Edit patient's exam item;
- **OK:** Save patient information;
- **Cancel:** Cancel the operation of new patient information;

**Operation Methods:**

1. Move the Trackball to the position of inputting character, and then input patient information by character keyboard.
2. Use the Trackball and the **[ENTER]** key to switch between different input options: ID, patient name, doctor's name, birthday (It can be automatically calculated when input age), age (It can be automatically calculated when input birthday), gender.
3. Select the exam items, and input the regular inspection information.
4. After inputting the required information, click on the **[OK]** key to save the patient information, the system will return to the B mode.
5. Recall information of the previous patient, you can use the Archive or Worklist to recall patient information to exam.

**⚠ CAUTION:** *Creating a diagnostic record, you should check the accuracy of the patient information before saving measurement or image; otherwise, it will be stored in the wrong patient records. After checking the patient, press the **[END]** key to save the patient information in the system.*

## 5.4 Image Interface Display

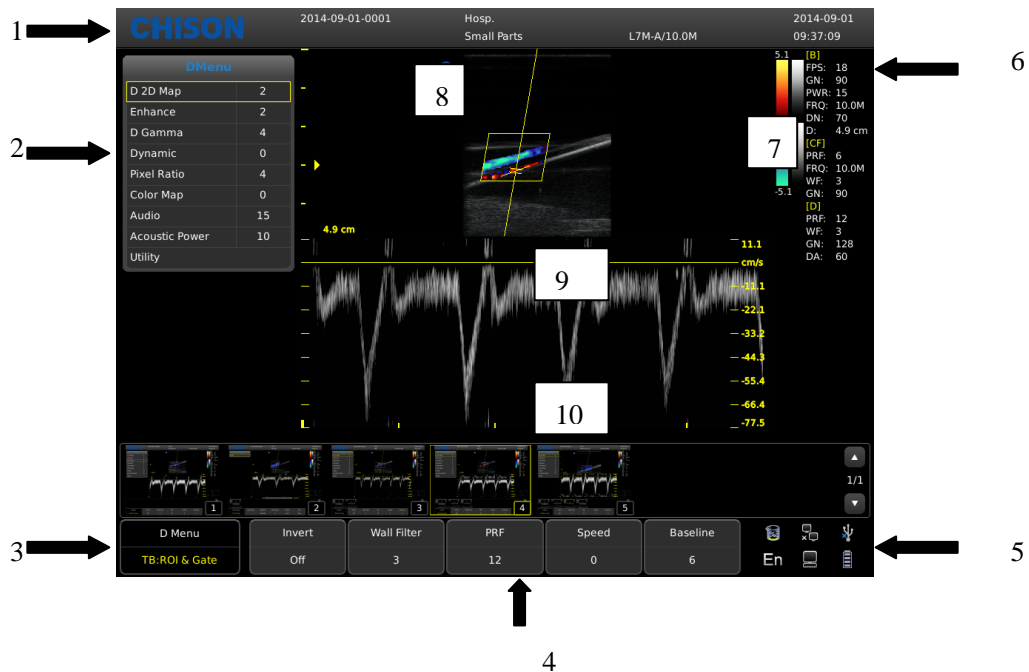

- 1, Logo 2, Control menu 3, Image status prompt 4, Image parameter area  
 5, System state prompt 6, Image parameter area 7, Gray-scale strip  
 8, Start point of scanning 9, Image Region 10, Cine loop

## 5.5 Display Mode

Display Mode: B, 2B, 4B, M, B/M, they can be shifted by the mode key.

### 5.5.1 B Mode

Press [B] Mode key, and display the single B Mode image, B Mode is the basic mode for two-dimensional scanning and diagnosis.

### 5.5.2 2B Mode

Press [2B] to display double B mode images side by side. One image is in real-time status; the other is in frozen status. The real-time image has start scan marker and ruler marker .Press 2B button in 2B mode, the original active image is frozen while the original frozen image is activated. In frozen status, Press [2B] to choose a B mode image to be activated when unfreezes the image.

### 5.5.3 4B Mode

Press [4B] button to enter into 4B mode, the screen will display four B mode images side by side, but only one image is in real-time status. Pressing it again can switch the real-time status among four images.

In frozen status, Press [4B] to choose a B mode image to be activated when unfreezing the image.

### 5.5.4 B/M Mode

Press [B/M] button, a real time B-mode image and a real-time M-mode image will be displayed at the same time. And a sample line will appear in the B-mode image area, which indicates the active sample position for M image on the B image area. Move the sampling line by trackball.

### 5.5.5 M Mode

Press [M] key again, B mode image will disappear; M mode image is still active on the whole screen. M mode image stands for the tissue movement status at the sampling line. The M mode image varies with time, so it is mainly used for cardiac applications.

### 5.5.6 CFM Mode

CFM is a Doppler mode intended to add color-coded qualitative information concerning the

relative velocity and direction of fluid motion within the B mode image.

CFM is useful to see flow in a broad area. It allows visualization of flow in the CROI, whereas Doppler mode provides spectral information in a smaller area. CFM is also used a stepping stone to Doppler mode. You can use CFM to locate flow and vessels prior to activating Doppler.

In CFM mode, move the trackball to change the position of sampling box. Activate the [**Steering Angle**] and rotate the [**MENU**] knob to adjust the angle of color sampling box (if current probe is linear probe). Press [**ENTER**] key to fix the position of color sampling box. At this time adjusts the size of color sampling box through moving trackball. Press [**ENTER**] key again and move trackball to change the color sampling position again.

Press [**C**] key to enter into CFM mode; after [**C**] key light is on, rotate the [**GAIN**] knob for adjusting the gain of CFM.

**CFM mode Exam Procedure:**

- Follow the same procedure as described under B mode to locate the anatomical area of interest.
- After optimizing the B mode image, add Color Flow.
- Move the color region of interest CROI as close to the center of the image as possible.
- Optimize the color flow parameters so that a high frame rate can be achieved and appropriate flow velocity can be visualized.
- Press [**FREEZE**] key to hold the image in cine memory.
- Record color flow image as necessary.

**CFM Scanning Hints:**

**PRF:** increase/decrease the PRF on the color bar. Imaging of higher velocity flow requires increased velocity scale values to avoid aliasing

**Wall Filter:** affect low flow sensitivity versus motion artifact

**Color Map:** allow you to select a specific color map. It shows the direction of the flow and highlights the higher velocity flows.

**Color Gain:** amplify the overall strength of echoes processed in the CROI

**Persistence:** affect temporal smoothing and color Doppler 'robustness'.

### 5.5.7 PW Mode

Doppler is intended to provide measurement data concerning the velocity of moving tissues and fluids. PW Doppler lets you examine blood flow data selectively from a small region called the Sample Volume.

The X axis represents time while the Y axis represents velocity in either a forward or reverse direction.

PW Doppler is typically used for displaying the speed, direction, and spectral content of blood flow at selected anatomical sites.

PW Doppler can be combined with B mode for quick selection of the anatomical site for PW Doppler examination. The site where PW Doppler data is derived appears graphically on the B mode image (Sample Volume Gate). The Sample Volume Gate can be moved anywhere within B mode image.

#### **PW mode Exam Procedure:**

- Get a good B mode image. Press [**C**] key to help locate the vessel you wish to examine.
- Press [**D**] key to display the sample volume cursor and gate.
- Position the sample volume cursor by moving the Trackball left and right. Position or re-size the sample volume gate by moving the Trackball up and down, then press [**ENTER**] key.
- Press [**UPDATE**] key to display PW Doppler spectrum and the system will run in combined B+Doppler mode. The Doppler signal can be heard through the speakers.
- Optimize the PW Doppler spectrum as necessary.
- Ensure that the sample line is parallel to the blood flow.
- Press [**FREEZE**] key to hold the trace in cine memory and stop imaging.
- Perform measurements and calculations, as necessary.
- Record results with your recording devices.
- Press [**FREEZE**] key to resume imaging.
- Repeat the above procedure until all relevant flow sites have been examined.
- Replace the probe in its respective holder.

When entering Duplex mode for the first time, the Doppler spectrum is not activated. The Doppler Sample Volume appears in the default position, and the B mode image or 2D (either B or Color) mode are active. Moving the Trackball will change the Sample Volume position. Press the **[ENTER]** key to toggle the Trackball function between Sample Volume Gate position and size. Press the **[UPDATE]** key after the Sample Volume Gate is defined to activate the Spectral Doppler mode. Press the **[UPDATE]** key for second time to toggle back to 2D (B or Color) update and deactivate the Spectral Doppler.

### **Doppler mode Scanning Hints:**

The best Doppler data will be got when the scanning direction is parallel to the direction of the blood flow; when the scanning direction is perpendicular to the anatomic target, you can get the best B mode image, so you should keep the balance as you don't usually get both an ideal B mode image and ideal Doppler data simultaneously.

**PRF:** adjust the velocity scale to accommodate faster/slower blood flow velocity. Velocity scale determines pulse repetition frequency.

**Wall Filter:** remove the noise caused by vessel or heart wall motion at the expense of low flow sensitivity.

**Baseline:** adjust the baseline to accommodate faster or slower blood flows to eliminate aliasing.

**Angle:** optimize the accuracy of the flow velocity. It estimates the flow velocity in a direction at an angle to the Doppler vector by computing the angle between the Doppler vector and the flow to be measured. This is special useful in vascular applications where you need to measure velocity.

**Doppler Gain:** allow you to control the background information of spectral.

**Sweep Speed:** control speed of spectral update.

### **Doppler Sample Volume Gate Position and Size (Trackball and ENTER)**

Move the sample volume on the B mode's Doppler cursor. The gate is positioned over a specific position within the vessel.

- To move Doppler cursor position, turn the trackball left or right until positioned over the vessel.
- To move sample volume gate position, move the trackball up or down until positioned inside the vessel.

➤ To size sample volume gate, press **[ENTER]** key to toggle trackball function from sample volume gate positioning to sizing, then move the trackball to change sample volume gate size.

## 5.6 B Image Adjustment

### 5.6.1 Frequency

In real status, press the first line key of **[Frequency]** to increase the frequency, and press the second line key of **[Frequency]** to decrease the frequency.

### 5.6.2 Dynamic

Dynamic range is used for adjusting the contrast resolution of B mode image and mode image, compressing or enlarging the display range of gray scale.

At the real-time status, press the first line key of **[Dynamic]** to increase the Dynamic, and press the second line key of **[Dynamic]** to decrease the Dynamic. The range is 30 to 90.

### 5.6.3 i-Image

In real status, press the corresponding key of **[i-Image]** to adjust, the range is 0~3.

### 5.6.4 Compound

In real status, press the corresponding key of **[Compound]** to adjust, and the range is 0~3. The SRA can't be edited after opening the compound.

### 5.6.5 SRA

In real status, press the corresponding key of **[SRA]** to turn on or off.

### 5.6.6 M Speed Adjustment

In real M status, press the corresponding key of **[Speed]** to adjust M speed, and the range is 1~4.

### 5.6.7 Gain

In real status, rotate **[GAIN]** knob to adjust the Gain, and the range is 0~255, the step is 5.

### 5.6.8 STC

STC curves can be used for adjusting gain compensation in different image depth.

Drag the slide of STC to adjust the value.



STC curve will disappear automatically 1 second later after stopping adjustment.

### 5.6.9 Depth

Press [DEPTH/FOCUS] selection knob until the indicator of [DEPTH] is lit, and then rotate the knob to change the depth of image.

### 5.6.10 Focus Position

Press the [DEPTH/FOCUS] selection knob until the indicator of [FOCUS] is lit. Then turn the knob to change Focus Position.

### 5.6.11 Angle

Change the angle of sampling line of sampling gate in PW mode.

Press [ANGLE/ZOOM] confirms the light of ANGLE on, the sampling line rotates with the direction.

### 5.6.12 ANGLE/ZOOM

Press [ANGLE/ZOOM] knob until the indicator of [ANGLE] is lit, and the angle of sample gate will rotate with the rotation direction.

Press [ANGLE/ZOOM] knob to confirm the ZOOM button is lit, and it will appear the zoom box, rotate the knob to select the zoom steps.

### 5.6.13 INVERT

B mode image and B/M mode image can be reversed horizontally and vertically.

Press the  key, the displayed image is reversed in the right-left horizontal direction.

Press the  key, the displayed image is reversed in the up-down vertical direction.

The horizontal flip status indicators of the upper-left corner of the image window have the following meanings:

The meaning of the symbol “○” indicating the probe initiative scanning position “○” situated in the left indicates that the first scanning line in the left of the screen is corresponding to the initiative scanning position of the probe,

“○” situated in the right indicates that the first scanning line in the right of the screen is corresponding to the initiative scanning position of the probe.

## 5.6.14 THI

Turn ON/OFF THI

## 5.6.15 AIO

Only press this key to optimize image.

# 5.7 B Image Menu Adjustment

Click **[Change]** key or **[MENU]** knob to display the menu.

Rotate **[MENU]** knob or press **[Cursor]** key to display the cursor, and move the sample box to the corresponding function, press **[MENU]** knob to update the function, then rotate **[MENU]** knob to adjust the function, press **[MENU]** again to exit the function.

## 5.7.1 Scan Width

Select **[Scan Width]**, and adjust the scan width to the corresponding size.

## 5.7.2 Focus Num

In B mode, 4 focus points can be selected simultaneously, and the number controlled by the depth, SRA and Compound.

Move the cursor to **[Focus Num]** selection to adjust, and the range is 1~4. When Compound or SRA is on, Focus Num can be adjusted to 2 (max).

## 5.7.3 Persistence

In real status, adjust the contrast and resolution.

In real status, press the first line key of **[Persistence]** to adjust. The range is 0~7.

## 5.7.4 Line Density

Scan Line Density function is only valid for the image in B mode, 2B mode, B/M mode or 4B mode image. The line density has two types: high density and low density. High density means better image quality while low density image has higher frame rate.

To do the adjustment, please select the submenu item **[Density]** and press **[MENU]** to adjust the line density.

### 5.7.5 Smooth

Smoothness function is used for restraining the image noise and performing axial smooth processing to make the image smoother.

Move the cursor to [**Smooth**] selection to adjust, and the range is 0~7.

### 5.7.6 Edge Enhance

Edge enhancement is used for enhancing the image outline. In this way the user can view the tissue structure more clearly.

Move the cursor to [**Edge**] selection to adjust, and the range is 0~7.

### 5.7.7 Acoustic Power

Acoustic power means the acoustic power transmitting from the probe.

At the real-time status, Move the cursor to [**Acoustic power**] selection to adjust.

### 5.7.8 Utility

This function includes post processing, slide show and other items. Press [**MENU**] knob, then choose Utility selection, it will appear Utility options.

#### 5.7.8.1 Post Processing

- **Chroma**

Adjust the type of the chroma.

Choose [**Chroma**], and rotate [**MENU**] button to select the Chroma type.

- **2D Map**

Select the type of the scale curve.

Choose [**2D Map**], and rotate [**MENU**] button to select the scale curve type.

- **B Gamma**

Adjust image gray value parameters.

Choose [**B Gamma**], and rotate [**MENU**] button to select the B Gamma parameters.

- **B Rejection**

Adjust image gray scale inhibition parameters.

Choose [**B Rejection**], and rotate [**MENU**] button to adjust B Rejection parameters.

## 5.7.9 Advance

In B Mode, select Advance, after pressing **[MENU]** knob, it will appear Advance options.

### 5.7.9.1 Zoom Coef

Adjust the size of the ruler and image.

Choose **[Zoom Coef]**, and rotate **[MENU]** button to adjust, the range is 60%~100%.

### 5.7.9.2 MB

Through opening MB to improve image quality.

Press **[MENU]** to turn on or turn off the MB function.

### 5.7.9.3 Trapezoidal Mode

Press **[MENU]** to turn on or turn off the trapezoidal function. This function is activated by linear probes.

### 5.7.9.4 Biopsy

Show or hide biopsy.

Press the **[MENU]** to show or hide biopsy line.

After the biopsy line shows, press the **[ENTER]** key to activate the adjustment function of biopsy line, horizontal rolling the trackball can translate the biopsy line, vertical rolling the trackball can adjust the line angle, press the **[UPDATE]** key to set the default biopsy line position.

## Accessories

To order biopsy guides; and other supplies and accessories, contact CIVCO Medical Solutions:

CIVCO Medical Solutions

102 First Street South, Kalona, IA 52247-9589

Telephone: 800-445-6741 (USA and Canada), +1 319-656-4447 (International)

Fax: 877-329-2482 (USA and Canada), +1 319-656-4451 (International)

E-mail: [info@civco.com](mailto:info@civco.com)

Internet: [www.civco.com](http://www.civco.com)

### **NOTE:**

*Model or part numbers in the following tables are subject to change.*

*Biopsy Guides*

Transducer	Compatible Biopsy Guide Model
V6-A	610-1093 (10041823)

### 5.7.9.5 Center Line

Show or hide Center Line.

Press the **[MENU]** to show or hide Center line.

## 5.8 CFM Image Adjustment

### 5.8.1 Color Map

Change the type of Color Map

Activate the **[Color Map]** and rotate **[MENU]** to adjust Color Map, adjustment range from 0~8.

### 5.8.2 Color Invert

Invert the color of flow

Activate **[Color Invert]** and rotate **[MENU]** to turn on or off. Or press  to realize Color invert.

### 5.8.3 Contrast

Adjust the contrast of color

Activate **[Contrast]** and rotate **[MENU]** to adjust contrast, adjustment range from 0~8.

### 5.8.4 Steering Angle

Adjust Steering Angle.

Activate **[Steering Angle]** and rotate **[MENU]** to adjust Steering Angle, adjustment range -10/-5/0/5/10.

### 5.8.5 Wall Thre.

Activate **[Wall Thre.]** and rotate **[MENU]** to adjust Wall Thre., adjustment range from 0~14.

### 5.8.6 Blood Effection

Activate **[Blood Effection]** and rotate **[MENU]** to adjust Blood Effection, adjustment range Smooth/Resolution.

### **5.8.7 Flow**

Adjust flow speed.

Activate [**Flow**] and rotate [**MENU**] to adjust flow, adjustment range low/middle/high.

### **5.8.8 Freq**

Adjust frequency of color mode.

Press parameter control key on [**Freq**] to change frequency, adjustment range depends on probe type.

### **5.8.9 Wall Filter**

Adjust Wall Filter.

Press parameter control key on [**Wall Filter**] to change Wall Filter , adjustment range from 0~3.

### **5.8.10 PRF**

Adjust PRF.

Activate [**PRF**] and rotate Menu to Adjust PRF, adjustment range from 0~15.

### **5.8.11 Persistence**

Adjust persistence.

Activate persistence and rotate [**MENU**], adjustment range from 0~7.

### **5.8.12 Baseline**

Adjust the position of baseline.

Press parameter control key on [**Baseline**] to change position of baseline, adjustment range from 0~6.

## **5.9 PW Image Adjustment**

### **5.9.1 D 2D Map**

Adjust D 2D Map.

Activate D 2D Map and rotate [**MENU**] adjustment range custom/1/2/3/4.

## 5.9.2 Enhance

Adjust Enhance.

Activate [**Enhance**] and rotate [**MENU**] to adjust Enhance, adjustment range from 0~3.

## 5.9.3 D Gamma

Adjust D Gamma.

Activate D gamma and rotate [**MENU**] to adjust D Gamma, adjustment range from 0~8.

## 5.9.4 Dynamic

Adjust Dynamic.

Activate [**Dynamic**] and rotate [**MENU**] to adjust Dynamic, adjustment range from 0~7.

## 5.9.5 Pixel Ratio

Adjust Pixel Ratio.

Activate [**Pixel Ratio**] and rotate [**MENU**] to adjust Pixel Ratio, adjustment range from 0~7.

## 5.9.6 Color Map

Change type of color map.

Activate [**Color map**] and rotate [**MENU**] to adjust D color map, adjustment range from 0~8.

## 5.9.7 Audio

Adjust audio volume.

Activate [**Audio**] and rotate [**MENU**] to adjust audio volume, adjustment range from 0~15.

## 5.9.8 Acoustic power

Change acoustic power.

Activate [**Acoustic power**] and rotate [**MENU**] to adjust acoustic power, adjustment range from 0~10.

## 5.9.9 Invert

Press parameter control key on Invert, or press  key to invert spectrum.

### 5.9.10 Wall Filter

Press parameter control key on [**Wall Filter**] to adjust wall filter, adjustment range from 0~3.

### 5.9.11 Speed

Press parameter control key on [**Speed**] to adjust speed, adjustment range from 0~2.

### 5.9.12 PRF

Adjust PRF.

Press parameter control key on [**PRF**] to adjust PRF, adjustment range from 0~15.

### 5.9.13 Baseline

Adjust the position of baseline.

Press parameter control key on [**Baseline**] to adjust the position of baseline, adjustment range from 0~6.

## 5.10 Full Screen Show

Full screen the image area. Press [**GAIN**] knob to activate the function; Press [**EXIT**] button or [**GAIN**] knob again to exit full screen show.

When full screen shows, press [**MENU**] knob to show the menu of current mode (except bodymark).

## 5.11 Edit Comment

### 5.11.1 Overview

The comment is to enter text or symbols on the image, the device is Chinese and English annotation system.

Enter COMMENT: Press  enter into comments status;

Exit COMMENT: Press  again or [**FREEZE**] key to exit;

Comment means input the words or symbols on images for making explanation. Add comments can through keyboard input directly or using the default comments.

The default comments are classified by examination mode as follows:





Classification	Function Description
Abdomen	Abdomen, general anatomy term
Obstetrics	Anatomy term of Obstetrics
Gynecology	Anatomy term of Gynecology
Heart	Anatomy term of Heart
Small Parts	Anatomy term of Small Parts
Pathological Change	Anatomy term of Pathological Change

 **NOTE:** If you need to custom the default comments, refer to the pre-set section.

### 5.11.2 Input Characters

Operation:

1. Press  button, then system will go into the comment process.
2. Move the cursor to the position where need to comments.
3. Input characters at cursor position by keyboard then press **[ENTER]** key to confirm.
4. Press  again to exit. The  will light off and the comments process is finished.

### 5.11.3 Input Comment Library Characters

1. In comment status, move trackball to image area to edit;
2. Press **[Font size]** to adjust front size of comments, the range is 10~20;
3. Rotate **[MENU]** to select needed comments, then press **[MENU]** to exit ;

### 5.11.4 Edit Quick Comments

1. Press **[Edit]** to pop quick comment edit box;
2. Input customized comments;
3. Press **[Done]** to finish edit, press **[X]** to cancel edit;

### 5.11.5 Input Quick Comments

1. Press **[Text]** to select needed quick comments;
2. Adjust front size of comments;
3. Press **[Input]** to place comments in the image area;

## 5.11.6 Move Comments

1. In comment status, move trackball to the comment, press **[ENTER]** to activate it;
2. Move trackball to place the comment to target area;
3. Press **[ENTER]** again to confirm the comment;

## 5.11.7 Edit Comments

1. In comment status, move trackball to the comment, press **[ENTER]** to activate it
2. Press **[BACKSPACE]** to delete unnecessary characters;
3. Press **[ENTER]** to confirm;

## 5.11.8 Delete Comments

### 5.11.8.1 Delete Characters

In comment status, activate the comment that need to be deleted, then press the **[ENTER]**, it will display "|" on the screen, press **[BACKSPACE]** to delete the character.

### 5.11.8.2 Delete Single Comment

Activate the comment that needs to be deleted, press **[DEL]** to delete comment;

### 5.11.8.3 Delete All Contents of the Comment

Don't activate the single comment; press **[DEL]** to delete all characters that has input.

 **CAUTION:** Press **[DEL]** key, but it will delete the measurement and body mark at the same time.

## 5.11.9 Set the Position of Default Comment

Operation:

1. Press **[Save Home Pos.]** to move cursor to the initial position;
2. Press **[Load Home Pos.]** to set the initial position;

## 5.12 Set Body Mark



### 5.12.1 General Description

The body mark indicates patient's examination position and the direction of probe scan on the image.

Body marks are divided into: obstetric, abdomen, gynecology, heart and small parts etc., each has different body mark. Each type of body mark automatically is corresponding to current examination mode.

### 5.12.2 Body Mark Operation

Operation:

1. Press  to enter into the body status.
2. Select the body mark that you need.
3. Move trackball after adding the body mark image and then adjust the position of probe. Rotate [MENU] or [ANGLE] knob can adjust the probe direction. Press Enter- key to confirm when adjustment was finished.
4. Move the Trackball to change the position of the body mark;
5. If you want to exit from the body mark function, press  again;
6. Press [EXIT] to exit body status and the body mark is fastened to the screen.
7. Press [DEL] to delete body marks.

## 5.13 Set the Direction of Arrow

Operation:

1. Press  to display arrow;
2. Press [Change] button to select cursor type: arrow or cross. And change the size of the cursor.
3. Adjust the position of probe. Rotate [MENU] or [ANGLE] knob can adjust the probe direction.
4. Press [ENTER] to confirm when adjustment was finished.
5. Press [EXIT] to exit the arrow settings.
6. Press [DEL] to clear the arrows has inputted.

## 5.14 Image and Cine Disposition

### 5.14.1 The Principle of Cine Storage

In real image status, the image can be stored in the movie memory in chronological order, maximum frames can be set. The maximum number of frames of the film storage can be set, please refer to pre-set chapter.

If the movie memory is full, the recent frame saved into memory, the previous frame removed from memory.

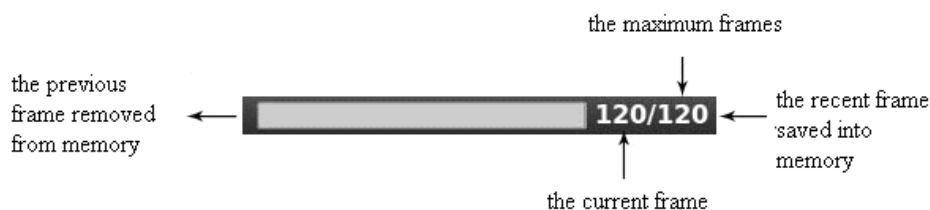

Cine loop indicate diagram

### 5.14.2 Manual Loop

Press **[FREEZE]** to freeze image, pop cine playback bar, at this time, move cursor to play by hand; Trackball rolling to the right, the loop play with ascending order side by side. Or press **[Next/Pre]** to play.

### 5.14.3 Automatic Loop

After freezing image, press **[Play/Pause]** to play, press it again to stop.

Press **[ENTER]** to choose the area of automatic playback area needed.

### 5.14.4 Save and Recall Image

Press  to save current image, the image will be displayed below the screen;

If you need to recall images that have been stored, move cursor to needed image, press **[ENTER]** to recall it; or you can recall archived patient's information to recall image, please refer to archive chapter.

### 5.14.5 Save and Recall Cine

In freeze status, press  to save cine, then it will be displayed below the screen, move cursor to needed cine, press [ENTER] to recall the cine.

### 5.14.6 Delete images

After recalling the images, press the [Delete images] to delete the files.

### 5.14.7 Send images

After recalling the images, press the [Send images] to send images to USB flash disk, DICOM storage and print.

Hint: Activate the DICOM before using DICOM storage and print.

## 5.15 Image Browse

Press  to enter image information browsing interface. Press [ENTER] to any function in the image.

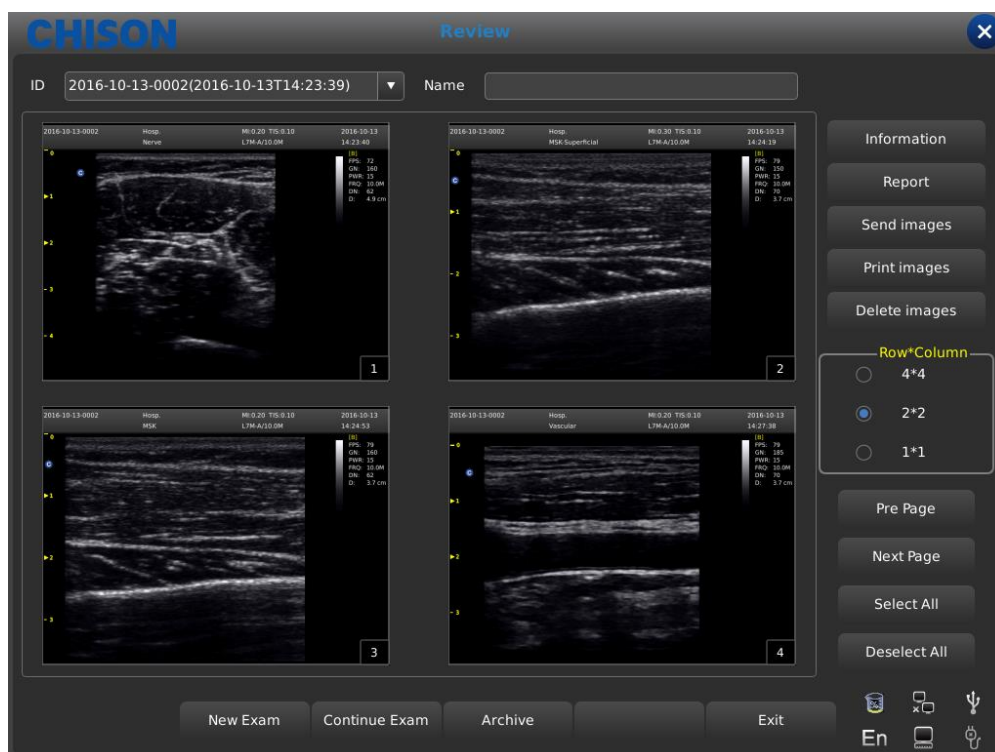

- **ID:** ID of Current patient.
- **Name:** Current patient's name.

- **Information:** Enter into current patient's information interface.
- **Report:** Enter into current patient's report interface;
- **Send images:** Send image to USB hard disk , DICOM storage and print;
- **Print the image:** print the image which be chosen, it will be printed as the arrangement set;
- **Delete images:** Delete selected image;
- **Row\*Column:** Select image's format;
- **Pre page:** Page up;
- **Next page:** Page back;
- **Select All:** Select all images;
- **Deselect All:** Cancel select all images;
- **New Exam:** Exit current examination and open a new dialog box.
- **Continue Exam:** Exit image browsing interface and go on checking current patient;
- **Archive:** Open up archive management interface;
- **Cancel:** Turn off image browsing interface;

## 5.16 Archive Management

Archive management can search for patient's information which has been stored in system. Press [Archive] to archive management interface, all process can be opened up by moving cursor.

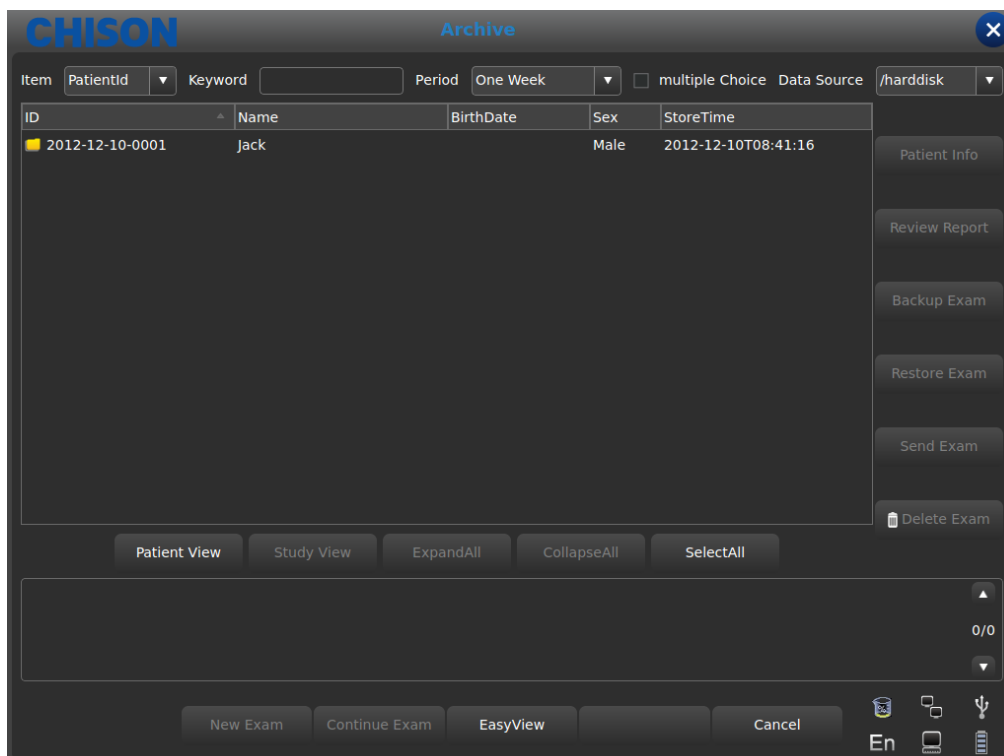

- **Item:** Type selection, select Patient's ID or Name;
- **Keyword:** Search for key words;
- **Period:** Time filter, select today, one week, one month, three months, six months, recent one year and all;
- **Multiple Choice:** Multiple choice;
- **Data Source:** Path choice, select hard disk or U disk;
- **Patient info:** Enter into patient's information interface;
- **Review Report:** Enter into report interface;
- **Backup Exam:** Select examination information to USB hard disk;
- **Restore Exam:** Recover examination information from USB hard disk;
- **Send Exam:** Send selected examination information remotely to USB hard disk or DICOM Storage/Print (Need to activate the DICOM);
- **Delete Exam:** Delete selected examination information;
- **Patient View:** Change display mode of information;
- **Expand All:** Select Patient View, it will display sub-directory;
- **Collapse All:** Exit sub-directory;
- **Select All:** Select all examination information;
- **New Exam:** Exit current patient's examination;
- **Continue Exam:** Exit archive management interface and go on checking current patient;
- **Easy View:** Exit archive management interface and open up image browsing interface;
- **Cancel:** Exit archive management interface and go on checking current patient;

## 5.17 Report

Press [ENTER] on the image to add the image into the report page. The report can be saved and printed. It is convenient for the doctor to view and edit the patients' information.

Reports contain normal report, abdominal report, cardiac report, small part report etc. Move the cursor to the required report page and press [ENTER] to choose.

Press the [Report] button and the page pop up the report page of the current exam mode. Change the other exam mode report by the drop-down box.



- **Report Title:** Report options, different kinds of report can choose, such as Normal, OB/GYN etc.
- **Hosp:** Display the hospital name.
- **Abdomen Report:** Display the kind of report.
- **Patient Name:** Display the patient name.
- **Age:** Display the patient age.
- **Sex:** Display the patient sex.
- **Patient ID:** Display the patient ID.
- **Diagnostic:** Input the diagnostic instructions.
- **Description:** Input the description of symptom.
- **Tips:** Input note information.
- **Send DICOM SR:** After activating DICOM , send DICOM structural report to server
- **Print:** Print the report with image.
- **Export:** Export the PDF report to the U disk.
- **Save:** Save the report in system.
- **The image on the right side:** Press [ENTER] on the image to add the image into the report.



## 5.18 DICOM

### 5.18.1 DICOM Worklist

Press [**Worklist**] in Patient Interface, pop up the following dialog box.

ID	Name	BirthDate	Sex	Doctor	Acc#
----	------	-----------	-----	--------	------

- **ID:** input ID or some characters, fuzzy query needs server;
- **Search By:** select term, ID or name;
- **ID:** display the ID of patients;
- **Name:** display the names of patients;
- **BirthDate:** display the birth date of patients;
- **Sex:** display sex of patients;
- **Doctor:** display names of doctors;
- **Acc#:** display the accession number of patients;
- **Search:** press this button to do search operation;
- **Apply:** select the searched patient and press this button, input all patient information into the new patient interface;
- **Clear:** clear all searched content.

## 5.18.2 DICOM Storage

Check the “save and send” in setting, then DICOM storage when saving cine and images. Press send button in archive or freeze interface. DICOM Send interface as follows:

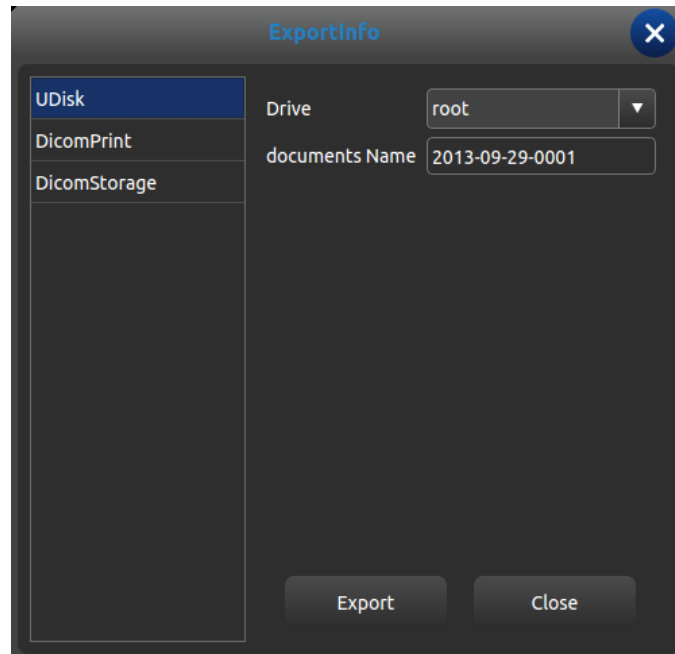

Select DICOM Storage in left, choose DICOM server and press Export button to DICOM storage. Enter Task Sequence and watch or edit DICOM process.

## 5.18.3 DICOM Print

DICOM Print operation is the same as DICOM storage.

## 5.18.4 DICOM SR

Press [**Send DICOM SR**] button in report interface, this task is added into Task Sequence.

# Chapter 6 Measurement and Calculation

Main content of this chapter:

Normal calculation and measurement on B mode image and M mode image, OB calculation and Urology measurement etc., system can enter into corresponding measurement mode depend on current exam mode, and enter into the corresponding report depend on the measurement mode.

System has built-in the default measurements according to the exam mode, the change of measurement please refer to the chapter of preset settings.

**⚠ CAUTION:** *Please select the most appropriate ultrasound images, measurement tools and measurement methods for measurements according to your diagnosis needs. The final measurement results must be determined and verified by a physician. Measurement accuracies are affected by many non-technical factors, for example operator's experience, patient's status. Please do not only use the ultrasound measurement results as the sole basis for diagnosis, please always use other clinical information to do integrated diagnostics.*

## 6.1 Keyboard for Measurement

### 6.1.1 Trackball

Trackball is used to move the cursor, main functions are as follows:

1. Before starting a measurement, use the trackball to choose the menu options;
2. After starting a measurement, move the trackball to move the cursor, during the measurement, the cursor should not be moved out image area;
3. During the Ellipse method measurement, use trackball to change the length of short axis.
4. Update the moving of the measurement result, move the trackball to change the position of the measurement result.

### 6.1.2 [ENTER]

During the measurement, the functions of [ENTER] are as follows:

1. When cursor is on the menu, press the key to choose the options and start the measurement.
2. During the measurement, press the key to anchor the start point and end point.

### 6.1.3 [UPDATE]

1. Before the measurement, press [UPDATE] to change the measurement method, such as ellipse, trace. The changeable measurement item has "< >".
2. During the measurement, [UPDATE] is used to switch the start point and end point, long axis and short axis when the measurement is not finished.
3. During the distance measurement, press the [ENTER] to fix the start point, when the end point is not fixed, press [UPDATE] to switch the start point and end point.
4. During the Ellipse measurement, when fix the long axis, but the short axis is not fixed, press [UPDATE] to switch the long axis and short one.

### 6.1.4 [DEL]

Main functions are as follows:

In frozen status, press [DEL], delete all the measurement results, comments and traces.

### 6.1.5 [Change]

Press [Change] to switch other menu;

### 6.1.6 [Exit]

Press [Exit] to exit the measurement menu.

### 6.1.7 Parameters control button

Press the corresponding button to update the function and use the function.

## 6.2 B Mode general Measurement methods

The system B mode contains Distance, Ellipse, and Trace.

### 6.2.1 Meas. Distance

Measurement steps:

1. Press the [Calc] button to enter into measurement. Update the [distance] item in the menu or press the quick measure button [Dist]; it will display a segment "+" icon.
2. Move the "+" icon by trackball to fit the one point of the line. Press [ENTER] to fix the start point

and the cursor can be moved to the next position.

3. Press [**UPDATE**] can change the activated point, and fit the other point of the line.
4. Move the cursor to the end-point, press [**ENTER**] again to complete the measurement.
5. After the measurement, the result will display in the measurement results area.
6. Repeat the steps from 1 to 4 to start next “distance” measurement. Press [**DEL**] to delete all the measurements.

### **NOTE:**

*Each group of measurement is limited, if the measurement results beyond, it will begin a new group of measurement automatically.*

## **6.2.2 Ellipse**

Measurement steps:

1. Press the [**Calc**] button to enter into measurement. Update the [**Ellipse**] item in the menu or press the quick measure button [**Ellipse**]; it will display a segment “+” icon.
2. Move the “+” icon by cursor, Press [**ENTER**] to fix the point and the cursor can be moved to form a round.
3. Press [**UPDATE**] can exchange the activated point and the fixed point.
4. Move the cursor to the end-point of the ellipse, press [**ENTER**] to fix the axis, at the same time, the next axis be updated, and can change the size of the axis by the cursor.
5. Now press [**UPDATE**] can exit to the step 4.
6. After fixing the next axis, can press [**ENTER**] to complete the measurement.
7. After the measurement, the result will display in the measurement results area.
8. Repeat the steps from 1 to 6 to start next “ellipse” measurement. Press [**DEL**] to delete all the measurements.

### **NOTE:**

*Each group of measurement is limited, if the measurement results beyond, it will begin a new group of measurement automatically.*

## **6.2.3 Trace**

Measurement steps:

1. Press the [**Calc**] button to enter into measurement. Update the [**Trace**] item in the menu or press the quick measure button [Trace]; it will display a segment “+” icon.
2. Move the “+” icon by cursor, Press [**ENTER**] to fix the point and the cursor can be moved to the next position.
3. Make the cursor tracing along the edge of required area, the traced line can be not closed.
4. Now press [**UPDATE**] to cancel the tracing.
5. Press [**ENTER**] again in the endpoint, the start point and end point of trace line will be closed by a straight line.
6. After the measurement, the result will display in the measurement results area.
7. Repeat the steps from 1 to 5 to start next “trace” measurement. Press [**DEL**] to delete all the measurements.

### **NOTE:**

*Each group of measurement is limited, if the measurement results beyond, it will begin a new group of measurement automatically.*

## **6.2.4 Histogram**

Histogram is used to calculate the gray distribution of the ultrasound echo signals within a specified area. Use the rectangle, ellipse or trace method to draw along the desired measurement area. The result is shown in the form of histogram.

Histogram can be measured only on the frozen image.

### ◆ Measurement steps by rectangular method:

1. Press [**Calc**] to enter into measurement, press [**Change**] to switch measurement menu to [**General**] measurement.
2. Press [**ENTER**] on [**Histogram**] menu to enter into measurement status.
3. Press [**ENTER**] to fix one apex of the rectangle.
4. Move the trackball to change the cursor position and fix the diagonal point of the rectangle
5. Move the trackball to change the cursor position, fix the diagonal point of the rectangle, and press [**ENTER**] again to confirm the measurement area. The result will display on the measurement result area.

### ◆ Measure the histogram by ellipse or trace method: The method is the same as that to measure

ellipse or trace method, press [**UPDATE**] to change the measurement between ellipse and trace.

The horizontal axis represents the gray scale of the image ranging from 0 to 255.

The vertical axis represents the distribution ratio of each gray scale. The value shown on the top of vertical axis represents the percentage of the maximally distributed gray in the whole gray distribution.

### 6.2.5 Cross-section Diagram

Cross-section Diagram is used to measure the gray distribution of the ultrasound signals in the vertical or horizontal direction on a certain profile (section).

This measurement is only available in the frozen mode.

Measurement steps:

1. Press [**Calc**] to enter into measurement, press [**Change**] to switch measurement menu to [**General**] measurement.
2. Press [**ENTER**] on [**Profile**] menu to enter into measurement status.
3. Draw a straight line at the measuring position. The method is the same as that to measure distance.
4. The calculated result of the profile will be displayed at the center of the screen.

1-The horizontal (or vertical) axis represents the projection of the profile line on the horizontal direction.

2-The vertical (or horizontal) axis represents the gray distribution of the corresponding points on the profile line. The range is 0 to 255.

### 6.3 B Fast Measurement

Press [**Dist**] to enter B Fast measurement in B mode. Press the corresponding parameter control key to switch the fast measurement item.

Meas. Menu	Submenu	Unit	Meas. Method/ Meas. Formula	Comment
Distance	Distance	cm	Refer to distance Meas.	
	Ratio(Distance)		Refer to distance Meas. Formula: $R=D1/D2$	D1: First Distance D2: Second Distance

Meas. Menu	Submenu	Unit	Meas. Method/ Meas. Formula	Comment
	Angle	deg	Refer to distance Meas.	
Area	area/circle	Area cm <sup>2</sup> Circle cm	Refer to Ellipse and trace meas.	Ellipse and trace.
Volume	Volume (1straight line)	ml	Refer to distance Meas. Formula: $V = (\pi/6) \times D3$	D means: Depth
	Volume (1ellipse)	ml	Refer to ellipse meas. Formula: $V = (\pi/6) \times A \times B2$	A: Long Axis B: Short Axis
	Volume (2 straight line)	ml	Refer to distance Meas. Formula: $V = (\pi/6) \times D1 \times D22$	D1: the longer distance D2: the shorter distance
	Volume (3 straight line)	ml	Refer to distance Meas. Formula: $V = (\pi/6) \times D1 \times D2 \times D3$	D1, D2, D3: Distance
	Volume(1 straight line 1 ellipse)	ml	Refer to distance and ellipse Meas. Formula: $V = (\pi/6) \times A \times B \times M$	A: Long Axis B: Short Axis M: Distance

## 6.4 B General Measurement

Press **[B]**, **[2B]** or **[4B]** to enter into B, 2B or 4B mode, and then press **[Calc]** to enter into measurement status. Or press **[Change]** to choose the General measurement.

Meas. Menu	Submenu	Unit	Meas. Method/ Meas. Formula	Comment
	Distance	cm	Refer to distance Meas.	
	area/circle	Area cm <sup>2</sup> Circle cm	Refer to Ellipse and trace meas.	Press <b>[UPDATE]</b> to change ellipse and trace.
	Volume (1straight line)	ml	Refer to distance Meas. Formula: $V = (\pi/6) \times D3$	D means: Depth
	Volume (1ellipse)	ml	Refer to ellipse meas. Formula: $V = (\pi/6) \times A \times B2$	A: Long Axis B: Short Axis



Meas. Menu	Submenu	Unit	Meas. Method/ Meas. Formula	Comment
	Volume (2 straight line)	ml	Refer to distance Meas. Formula: $V = (\pi/6) \times D1 \times D2$	D1: the longer distance D2: the shorter distance
	Volume (3 straight line)	ml	Refer to distance Meas. Formula: $V = (\pi/6) \times D1 \times D2 \times D3$	D1, D2, D3: Distance
	Volume(1 straight line and 1 ellipse)	ml	Refer to distance and ellipse Meas. Formula: $V = (\pi/6) \times A \times B \times M$	A: Long Axis B: Short Axis M: Distance
Ratio	Ratio(distance)		Refer to distance Meas. Formula: $R = D1/D2$	D1: First Distance D2: Second Distance
	Ratio(area)		Refer to ellipse Meas. Formula: $R = A1/A2$	A1: First Area A2: Second Area
Angle		deg	Refer to distance Meas.	
Histogram			Refer to histogram	
Cross-section diagram			Refer to Cross-section	

## 6.5 ABD Measurement

Choose ABD exam mode. Freeze the required image, and then Press [**Calc**] to enter into ABD measurement status. Or press [**Change**] to choose the ABD measurement.

Meas. Menu	Submenu	Unit	Meas. Method/ Meas. Formula	Comment
Distance		cm	Refer to distance Meas.	
CBD				
GB wall				
Liver Length				
	Height			
	Width			
Pro Aorta Mid Aorta Distal Aorta	StD%	%	Refer to distance Meas. Formula: $((D1 - D2) \div D1) \times 100\%$	D1: Length of Normal D2: Length of Stenosis
	StA%	%	Refer to ellipse Meas. Formula: $((A1 - A2) \div A1) \times 100\%$	A1: Area of Normal A2: Area of Stenosis

Meas. Menu	Submenu	Unit	Meas. Method/ Meas. Formula	Comment
	Vessel Area	cm <sup>2</sup>	Refer to ellipse and trace Meas.	Press <b>[UPDATE]</b> to change ellipse and trace.
	Vessel Dis	cm	Refer to distance Meas.	
Spleen	Length Height Width Volume	cm cm cm ml	Refer to distance Meas. Formula: $V = (\pi/6) \times L \times H \times W$	L: Length H: Height W: Width
Renal Vol. (Rt/Lt)	Length Height Width	cm	Refer to distance Meas.	
Liac(Rt/Lt)	Height	cm	Refer to distance Meas.	
	Width	cm	Refer to distance Meas.	
	StD%	%	Refer to distance Meas. Formula: $((D1-D2) \div D1) \times 100$ %	D1: Length of Normal D2: Length of Stenosis
	StA%	%	Refer to ellipse Meas. Formula: $((A1-A2) \div A1) \times 100$ %	A1: Area of Normal A2: Area of Stenosis
	Vessel Area	cm <sup>2</sup>	Refer to ellipse and trace Meas.	Press <b>[UPDATE]</b> to change ellipse and trace.
	Vessel Dis	cm	Refer to distance Meas.	

## 6.6 OB Measurement

Choose OB exam mode. Freeze the required image, and then Press **[Calc]** to enter into OB measurement status. Or press **[Change]** to choose the OB measurement.

Meas. Menu	Submenu	Unit	Meas. Method	Comment
Distance		cm	Refer to distance Meas.	
GS				Formula to choose: CFEF, Campbell, Hadlock, Hansmann, Korean, Merz, Shinozuka
CRL				Formula to choose: Hadlock, Hansmann, Korean, Nelson, Osaka, Rempen, Robinson, Shinozuka

Meas. Menu	Submenu	Unit	Meas. Method	Comment
BPD				Formula to choose: Bessis, CFEF, Campbell, Chitty, Hadlock, Hansmann, Jeanty, Johnsen, Korean, Kurtz, Merz, Osaka, Rempen, Sabbagha, Shinozuka
HC		cm	Refer to ellipse and trace Meas.	Formula to choose: CFEF, Campbell, Chitty, Hadlock, Hansmann, Johnsen, Korean, Merz
AC		cm	Refer to ellipse and trace Meas.	Formula to choose: CFEF, Campbell, Hadlock, Hansmann, Korean, Merz, Shinozuka
Fetal Biological	YS	cm	Refer to distance Meas.	
	OFD			Formula to choose: Hansmann, Korean
	APPD			Formula: Bessis
	TAD			Formula: CFEF
	TCA			Formula: Osaka
	FL			Formula to choose: Bessis, CFEF, Campbell, Chitty, Doubilet, Hadlock, Hansmann, Hohler, Jeanty, Johnsen, Korean, Merz, Osaka, Shinozuka
	Spine Long			
	APD			Formula: Hansmann
	TTD			Formula: Hansmann
TC				
Fetal Long Bones	HL	cm	Refer to distance Meas.	Formula to choose: Jeanty, Korean, Merz, Osaka
	Ulna Long			Formula: Jeanty
	Tibia Long			Formula to choose: Jeanty, Merz
	Radius Long			
	Fibula Long			
	Clavicle Long			Formula: Yarkoni
Fetal Cranium	Cerebellum	cm	Refer to distance Meas.	Formula to choose: Chitty, Hill
	Posterior Cistern			
	NF			
	NB			
	OOD			Formula: OOD
	IOD			

Meas. Menu	Submenu	Unit	Meas. Method	Comment
	NB			
	Paracele			Formula: Tokyo
	HC Width			
OB Others	LtRenal	cm	Refer to distance Meas.	
	RtRenal			
	LtRenalAP			
	RtRenalAP			
	LVWrHEM			
	TAD			
EFBW		g	Refer to distance and ellipse Meas.	Modify the formula automatically according to EFBW formula in setting
AFI		cm	Refer to distance Meas.	AFI=AFI1+AFI2+AFI3+AFI4
FBP				
Cervical Length				

## 6.6.1 Twins Measurement

1. In the new patient OB page, choose the number of gestations from one to four.
2. In the measurement menu, press baby A, and then press [**Enter**] to switch babies, which could measure the babies separately.

## 6.6.2 EDD (estimated date of delivery) Estimation

### 6.6.2.1 Calculating EDD by LMP (Last menstrual period)

1. In the new patient OB page, update the LMP input box.
2. Choose the LMP from the date dialog box or input the LMP date directly.
3. The calculated EDD value will appear in the result measurement area of OB page.

### 6.6.2.2 Calculating EDD by BBT (Basal body temperature)

1. In the new patient OB page, update the Ovul.Date input box and input the bbt date.
2. The method is the same with the LMP method.

## 6.6.3 Growth curves

Function: Growth curves comparison is used to compare the measured data of the fetus with the normal growth curve in order to judge whether the fetus grows normally.

Measurement steps:

1. Finish the measurement of the OB item and get into the report page.
2. Choose the growth curve at the right list and press **[ENTER]** to display the growth curve.
3. Choose the growth curve need to display, and check it to show the growth curve on report.
4. Click **[✕]** icon on the dialog box to exit.

 **Tips:** *The abscissa of Growth curves is the gestational weeks calculated according to the LMP in patient information.*

## 6.7 Pediatric Measurement

Select OB mode, press **[Calc]** to enter OB mode, then enter into pediatrics mode. Or press **[Change]** to switch to pediatrics measurement menu.

### 6.7.1 HIP Angle

HIP function is used for evaluating the fetal hip growth. In order to make calculation, three lines need to be added on the image, which is to conform to the fetal anatomic structure. The system will calculate and display two angles for doctor's reference.

Measurement steps:

1. Choose **[HIP Angle]** menu item, and click it to enter into measurement.
2. Click on the line image region, and appear one line with "+" .Move the line to the target measurement region.
3. Rotate **[MENU]** knob to adjust the line angle, press **[ENTER]** key to fix the line.
4. Then appear the second line, adjust the line according to the step 3, and fix the line.
5. Fix the 3 lines, the measurement results of the angle appear in the district.

 **CAUTION:**

*D 3 shows bias line between protruding of conjunction and acetabular bone*

*D 2 shows direct line between osileum and acetabular bone*

*D 1 shows base line between cotyle, joint purse, gristle periosteum and ilium.*

*$\beta$  is the angle between D1 and D 2 (acute angle);  $\alpha$  is the angle between D 1 and D 3(acute angle).*

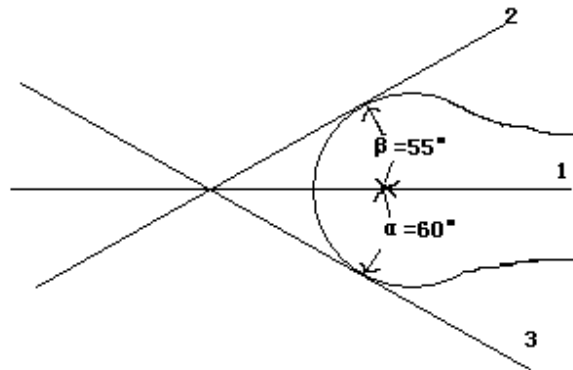

Fig. 6-1 HIP angle

## 6.8 GYN Measurement

GYN measurement includes measurement of UT-D (uterus diameter), ENDO (endometrium), CX-L (Uterine cervix length), LEFT OV and RIGHT OV (volume of left and right ovary) and LEFT FO and RIGHT FO (left and right follicle). The result will be calculated and displayed automatically on the screen by measuring relevant parameters.

Freeze the required image under GYN examination, then press **[Calc]** to enter into GYN measurement status.

Meas. Menu	Submenu	Unit	Meas. Method	Comment
Distance				
UT	UT_L	cm	Refer to distance Meas.	
	CX_L			
	UT_W			
	UT_H			
Cervix Vol.		ml	Refer to distance Meas. Formula: $V = (\pi/6) \times L \times H \times W$	L: Cervix_L H: Cervix_H W: Cervix_W
ENDO		cm	Refer to distance Meas.	
OV Vol.(L/R)		ml	Refer to distance Meas. Formula: $V = (\pi/6) \times L \times H \times W$	L: OV_L H: OV_H W: OV_W
FO(L/R)	Follicle width	cm	Refer to distance Meas.	
	Follicle height	cm	Refer to distance Meas.	

Meas. Menu	Submenu	Unit	Meas. Method	Comment
	Follicle Volume	ml	Formula of 2distance $V = (\pi/6) \times A \times B^2$ Formula of 3distance $V = (\pi/6) \times L \times H \times W$	2distance A: the longer distance B: the shorter distance 3distance L: follicle length H: follicle height W: follicle width

## 6.9 Small Parts Measurement

Freeze the required image under Small parts examination, then press [**Calc**] to enter into small parts measurement status.

Meas. Menu	Submenu	Unit	Meas. Method/ Meas. Formula	Comment
Distance		cm	Refer to distance Meas.	
Thyroid(L/R)	Volume	ml	Refer to distance Meas. Formula: $V = (\pi/6) \times L \times H \times W$	L: Thyroid_L H: Thyroid_H W: Thyroid_W
Angle		deg	Refer to distance Meas.	
Ratio			Refer to distance Meas. Formula: $R = D1/D2$	D1: First Distance D2: Second Distance

## 6.10 B Mode Vessel Measurement

Refer to normal measurement in B mode.

## 6.11 Urology Measurement

Normally urology measurements are performed in B and 2B mode.

Freeze the required image under Urology examination, then press [**Calc**] to enter into Urology measurement status.

Meas. Menu	Submenu	Unit	Meas. Method/ Meas. Formula	Comment
Kidney Vol.(L/R)		ml	Refer to distance Meas. Formula: $V = (\pi/6) \times L \times H \times W$	L: Kidney_L H: Kidney_H W: Kidney_w
Bladder Vol.	$V(L \times W \times H)$	ml	Refer to distance Meas. Formula: $V = (\pi/6) \times L \times H \times W$	L: Bladder_L H: Bladder_H W: Bladder_w

Meas. Menu	Submenu	Unit	Meas. Method/ Meas. Formula	Comment
Prostate	Volume	ml	Refer to distance Meas. Formula: $V = (\pi/6) \times L \times H \times W$	L: Prostate _L H: Prostate _H W: Prostate _w
	PPSA	ng/ml	Formula: $PPSA = 0.12 \times V$	
	PSAD	ng/ml	Formula: $PSAD = SPSA/V$	SPSA: input the SPSA When create a new Patient
RVU	Volume	ml	Refer to distance Meas. Formula: $V = (\pi/6) \times L \times H \times W$	L: RVU _L H: RVU _H W: RVU _w

## 6.12 Cardiac Measurement

Freeze the required image under Cardiac examination, then press [**Calc**] to enter into Cardiac status.

Meas. Menu	Unit	Meas. Method/ Meas. Formula	Comment
Distance	cm	Refer to distance Meas.	
Single Plane	ml	Refer to distance Meas. Formula: $V = (\pi/6) \times L \times D^2$	Left ventricular parameter at end diastole: LV long-axis SL; LV short-axis SD; Left ventricular parameter at end systole: LV long-axis DL; LV short-axis DD
Bi-Plane	ml	Refer to distance Meas., ellipse Meas. Formula: $V = (8/3) \times A_m \times A_i \div (\pi \times D)$	D: LV short-axis A <sub>m</sub> : LV area on mitral valve level figure A <sub>i</sub> : LV area on apex level figure
Bullet Volume	ml	Refer to distance Meas., ellipse Meas. Formula: $V = (5/6) \times A_m \times L$	A <sub>m</sub> : LV area on mitral valve short-axis figure L: LV long-axis
Modi_Simpson	ml	Refer to distance Meas., ellipse Meas. Formula: $V = (A_m + 5 \times A_p / 18) \times L$	A <sub>m</sub> : LV area on mitral valve short-axis figure A <sub>p</sub> : LV cross sectional on papillary muscle level figure. L: LV long-axis

## 6.13 Normal Measurement in M, B/M mode

At real-time status, press [**B/M**] twice to enter into M mode, press [**Calc**] to enter into M mode



measurement status. Or At real-time status, press **[B/M]** to enter into B/M mode, press **[Calc]** to enter into M mode measurement status.

### 6.13.1 Distance

Measurement steps:

1. Select menu item **[Distance]** to enter into measurement.
2. Click on the M image area, it will display a blue dotted line with two horizontal short line. The blue dotted line represents the position need to be measured. The distance between the two short lines is the distance you want to measure. The yellow short line represents it's in active status. Click it and drag the short line to anywhere you want to put.
3. Press **[UPDATE]** to active the two short lines in turns and drag them to change the distance between them. The measurement result will be displayed on the result area.

### 6.13.2 Time

Measurement steps:

1. Select menu item **[Time]** to enter into measurement.
2. Click on the M image area, it will display two blue straight dotted line. The blue dotted line with one yellow short line on it represents it is in active status. The distance between the two straight lines stands for time you want to measure. You can drag the active straight line to anywhere you want to change the measured time.
3. Press **[UPDATE]** to active the two straight lines in turns and drag them to change the distance between them. The measurement result will be displayed on the result area.

### 6.13.3 Heart rate

Heart rate is used to calculate the number of heart beats per minute from cardiac image.

Measurement steps:

1. Choose **[Heart rate]** menu item to enter into measurement.
2. The method is same as Time.
3. After the above measurement, the calculated heart rate result is displayed in the measurement result area.
4. Repeat the steps form1 to 3 to start next measurement.

### 6.13.4 Velocity

Measurement step:

1. Click [**Velocity**] to enter measurement condition.
2. Select the starting point and press [**ENTER**], the starting point and the removable cursor display, drag cursor to the end point.
3. Press [**ENTER**] again, measurement completes, the result displays in the region of measurement
4. Repeat 1~3, and enter the next measurement of velocity.

 **NOTE:** *The maximum number of the measurement result on the image area is one. The second measurement result will cover the first one. The measurement result area will list all the measurement values.*

### 6.14 General Measurement in M mode

At real-time status, press [**B/M**] key twice to enter M mode, press [**Calc**] to enter into M mode cardiology measurement status.

Meas. Menu	Submenu	Unit	Meas. Method/ Meas. Formula	Comment
Distance		cm	Refer to M distance Meas.	
Time		s	Refer to M time Meas.	
Velocity		cm/s	Refer to M velocity Meas.	
HR	One Cycle	bpm	Refer to M HR Meas.	
	Double Cycles	bpm	Refer to M HR Meas.	

### 6.15 M Abdomen Measurement

Refer to M mode general measurement.

### 6.16 M OB Measurement

Refer to M mode general measurement.

### 6.17 M GYN Measurement

Refer to M mode general measurement.

## 6.18 M Mode Cardiac Measurement

Normally urology measurements are performed in M and B/M mode.

Freeze the required image under Urology examination, then press [**Calc**] to enter into Urology measurement status. Or press [**Change**] to choose the cardiac measurement.

Meas. Menu	Submenu	Unit	Meas. Method/ Meas. Formula	Comment
Distance		cm	Refer to M distance Meas.	
ET		s	Refer to M time Meas.	
HR	One Cycle	bpm	Refer to M velocity Meas.	
	Double Cycles	bpm	Refer to M velocity Meas.	
LVMM	IVSd	cm	Refer to M distance Meas.	Interventricular Septum
	LVIDd			Left Ventricular Diameter at diastole
	LVIDs			Left Ventricular Diameter at systole
	LVPWd			Left Ventricular Posterior Wall at diastole
	IVSs			Interventricular Septal Thickness at Systole
	LVPWs			Left Ventricular Posterior Wall at Systole
	EDV	ml	$EDV = 7.0 / (2.4 + LVIDd) \times LVIDd^3$	Left Ventricular Volume at end diastole
	ESV	ml	$ESV = 7.0 / (2.4 + LVIDs) \times LVIDs^3$	Left Ventricular Volume at end Systole
	SV	ml	$SV =  EDV - ESV $	Stroke Volume
	SI		$SI = SV / BSA$	Stroke Volume, BSA: Body Surface Area, it calculated by inputting the height and weight.
	EF	%	$EF = SV / EDV \times 100$	Ejection Fraction
	FS	%	$FS = (LVIDd - LVIDs) / LVIDd \times 100$	Contraction Fraction
CO	L/min	$CO = SV \times HR / 1000$	Cardiac Output	

Meas. Menu	Submenu	Unit	Meas. Method/ Meas. Formula	Comment
	CI		$CI = CO/BSA$	ECG Index, BSA: Body Surface Area, it calculated by inputting the height and weight.
	LVMW		$LVMW = 1.04 \times [(IVSd + LVIDd + LVPWd)^3 - LVIDd^3] - 13.6$	
	LVMWI		$LVMWI = LVMW/BSA$	BSA: Body Surface Area, it calculated by inputting the height and weight.
	MVCF		$MVCF = (LVIDd - LVIDs) / (LVIDd \times LVET)$	Average Reduction of Length
Mitral Valve	EF Velocity	cm/s	Refer to M HR Meas.	
	AC Velocity	cm/s	Refer to M HR Meas.	
	A peak/E peak		Refer to M distance Meas.	
	Mitral Orifice Flow		Refer to M HR and time Meas. $QMV = 4 \times DEV \times DCT$	DEV: Mitral Valve Opening Velocity DCT: Mitral Valve Opening Time
Aorta	LAD/AOD		Refer to M distance Meas.	LV and aorta diametrical ratio
	Aortic Valvular Orifice Flow		$AVSV = (MAVO1 + MAVO2) \times LVET \times 50 + AA$	MAVO1: Aorta opening distance at the beginning. MAVO2: Aorta opening distance at the end. AA: Range of Aorta Wall Motion

## 6.19 M Urology Measurement

Refer to general measurement in M mode.

## 6.20 M Small Parts Measurement

Refer to general measurement in M mode.

## 6.21 M Pediatric Measurement

Refer to general measurement in M mode.

## 6.22 PW mode measurement methods

Press [PW] to enter PW mode, and then press [Calc] to enter PW mode measurement.

### **NOTE:**

- *In order to get accurate result, the PW image must be clear and high quality.*
- *Insure that you have fixed the cursor at the exact place of cardiac systole and diastole.*

### 6.22.1 Velocity

Refer to velocity of M mode general measurement.

### 6.22.2 Time

Refer to time of M mode general measurement.

### 6.22.3 HR

Refer to HR of M mode general measurement.

### 6.22.4 Auto Trace

Measurement step:

1. Move the trackball to select the start point of the one cycle and press [ENTER] to fix it.
2. A second cursor “^” will appear, and move the trackball to the end point of the cycle, press [ENTER] to fix it.
3. The measurement results will be displayed on the monitor and calculate other values of parameters.

### 6.22.5 Manual Trace

Measurement step:

1. Move the trackball to select the start point of the one cycle and press [ENTER] to fix it.
2. Move the trackball along the spectrum and press [ENTER] to complete.
3. The measurement results will be displayed on the monitor and calculate other values of parameters.

## 6.23 PW Fast Measurement

Press [Dist] to enter PW Fast measurement in PW mode. Press the corresponding parameter control key to switch the fast measurement item.

Meas. Menu	Submenu	Unit	Meas. Method/ Meas. Formula
Peak	Vs	cm/s	Refer to M speed meas.
	Pressure(s)	mmHg	Formula:Pressure=4×Vs×Vs/10000
	Vd	cm/s	Refer to M speed meas.
	Pressure(d)	mmHg	Formula:Pressure=4×Vd×Vd/10000
	SD		Formula:SD=Vs/Vd
	RI		Formula:SD=(Vs-Vd)/Vs
	Time	s	Refer to M time meas.
HR	Single wave	bpm	Refer to M HR meas.
Auto Trace/Manu al Trace	Vs	cm/s	Refer to M speed meas.
	Pressure(s)	mmHg	Formula:Pressure=4×Vs×Vs/10000
	Vd	cm/s	Refer to M speed meas.
	Pressure(d)	mmHg	Formula:Pressure=4×Vd×Vd/10000
	VMean	cm/s	Refer to M speed meas.
	Pressure(VMean)	mmHg	Formula:Pressure =4×VMean×VMean/10000
	TVI	cm	
	SD		Formula:SD=Vs/Vd
	RI		Formula:SD=(Vs-Vd)/Vs
	PI		Formula:SD=(Vs-Vd)/VMean
	HR(Single wave)	bpm	

## 6.24 PW General Measurement

Press [Calc] to enter PW measurement in PW mode. Press the corresponding parameter control key to switch the general measurement item.

Meas. Menu	Submenu	Unit	Meas. Method/ Meas. Formula
Velocity		cm/s	Refer to M speed meas.
Distance		cm	Refer to B distance meas.
Peak	Vs	cm/s	Refer to M speed meas.
	Pressure(s)	mmHg	Formula:Pressure=4×Vs×Vs/10000
	Vd	cm/s	Refer to M speed meas.

Meas. Menu	Submenu	Unit	Meas. Method/ Meas. Formula
	Pressure(d)	mmHg	Formula:Pressure = $4 \times Vd \times Vd / 10000$
	SD		Formula:SD = $Vs / Vd$
	RI		Formula:SD = $(Vs - Vd) / Vs$
	Time	s	Refer to M time meas.
Auto Trace/Manual Trace	Vs	cm/s	Refer to M speed meas.
	Pressure(s)	mmHg	Formula:Pressure = $4 \times Vs \times Vs / 10000$
	Vd	cm/s	Refer to M speed meas.
	Pressure(d)	mmHg	Formula:Pressure = $4 \times Vd \times Vd / 10000$
	VMean	cm/s	Refer to M speed meas.
	Pressure(VMean)	mmHg	Formula: Pressure = $4 \times VMean \times VMean / 10000$
	TVI	cm	
	SD		Formula:SD = $Vs / Vd$
	RI		Formula:SD = $(Vs - Vd) / Vs$
	PI		Formula:SD = $(Vs - Vd) / VMean$
	HR(Single wave)	bpm	
StD%	Distance1	cm	Refer to B distance meas.
	Distance2	cm	Refer to B distance meas.
	StD%	%	Formula:StD% = $((D1 - D2) \div D1) \times 100\%$
StA%	Area1	cm <sup>2</sup>	Refer to B ellipse meas.
	Area2	cm <sup>2</sup>	Refer to B ellipse meas.
	StA%	%	Formula:StA% = $((A1 - A2) \div A1) \times 100\%$
ICA/CCA	ICA	cm/s	Refer to M speed meas.
	Pressure(ICA)	mmHg	Formula:Pressure = $4 \times ICA \times ICA / 10000$
	CCA	cm/s	Refer to M speed meas.
	Pressure(CCA)	mmHg	Formula:Pressure = $4 \times CCA \times CCA / 10000$
	ICA/CCA		Formula:ICA/CCA
Flow Volume	Diam	cm	Refer to B distance meas.
	TVI	cm	
	Time	s	Refer to M time meas.
	HR(Single wave)	bpm	
	SV	ml	Formula: $0.785 \times Diam \times Diam \times  TVI $
	CO	l/min	Formula:SV*HR(Single wave)/1000

## 6.25 PW Abdomen Measurement

Refer to PW general measurement.

## 6.26 PW OB Measurement

Press [**Calc**] to enter PW measurement in PW OB mode. Or press the corresponding parameter control key to switch the OB measurement item.

Meas. Menu	Submenu	Unit	Meas. Method/ Meas. Formula
Umb A	Vs	cm/s	Refer to M speed meas.
	Pressure(s)	mmHg	Formula:Pressure = $4 \times Vs \times Vs / 10000$
Aorta	Vd	cm/s	Refer to M speed meas.
	Pressure(d)	mmHg	Formula:Pressure = $4 \times Vd \times Vd / 10000$
Descending Aorta	VMean	cm/s	Refer to M speed meas.
	Pressure(VMean)	mmHg	Formula: Pressure = $4 \times VMean \times VMean / 10000$
Uterine Artery(Lt)	TVI	cm	
Uterine Artery(Rt)	SD		Formula:SD = Vs/Vd
Pulmonary Artery	RI		Formula:SD = (Vs-Vd)/Vs
MCA	PI		Formula:SD = (Vs-Vd)/VMean
	HR(Single wave)	bpm	

## 6.27 PW GYN Measurement

Press [**Calc**] to enter PW measurement in PW GYN mode. Or press the corresponding parameter control key to switch the GYN measurement item.

Meas. Menu	Submenu	Unit	Meas. Method/ Meas. Formula
Umb A MCA Uterin A Fetal AO	Vs	cm/s	Refer to M speed meas.
	Pressure(s)	mmHg	Formula:Pressure = $4 \times Vs \times Vs / 10000$
	Vd	cm/s	Refer to M speed meas.
	Pressure(d)	mmHg	Formula:Pressure = $4 \times Vd \times Vd / 10000$
	VMean	cm/s	Refer to M speed meas.
	Pressure(VMean)	mmHg	Formula: Pressure = $4 \times VMean \times VMean / 10000$
	TVI	cm	
	SD		Formula:SD = Vs/Vd
	RI		Formula:SD = (Vs-Vd)/Vs
	PI		Formula:SD = (Vs-Vd)/VMean



Meas. Menu	Submenu	Unit	Meas. Method/ Meas. Formula
	HR(Single wave)	bpm	

## 6.28 PW Cardiology Measurement

Press [**Calc**] to enter PW measurement in PW cardiology mode. Or press the corresponding parameter control key to switch the cardiology measurement item.

Meas. Menu	Submenu	Unit	Meas. Method/ Meas. Formula
LVOT	Peak Velocity	cm/s	Refer to M speed meas.
	Peak Pressure	mmHg	Formula: Pressure = $4 \times \text{Peak Velocity} \times \text{Peak Velocity} / 10000$
	Diam	cm	Refer to B distance meas.
	Diam Area	cm <sup>2</sup>	Formula: $\pi \times \text{Diam} \times \text{Diam} / 4$
	Vs	cm/s	Refer to M speed meas.
	PPG	mmHg	Formula: $\text{PPG} = 4 \times \text{Vs} \times \text{Vs} / 10000$
	VMean	cm/s	Refer to M speed meas.
	MPG	mmHg	Formula: $\text{MPG} = 4 \times \text{VMean} \times \text{VMean} / 10000$
	TVI	cm	
	Time	s	Refer to M time meas.
	HR(Single wave)	bpm	
	SV	ml	Formula: $0.785 \times \text{Diam} \times \text{Diam} \times  \text{TVI} $
	CO	l/min	Formula: $\text{SV} \times \text{HR}(\text{Single wave}) / 1000$
AV	Diam	cm	Refer to B distance meas.
	Area	cm <sup>2</sup>	Refer to B trace meas.
	ACC	cm/s <sup>2</sup>	Refer to M speed meas.
	AV Trace Vs	cm/s	Refer to M speed meas.
	AV Trace PPG	mmHg	Formula: $\text{PPG} = 4 \times \text{Vs} \times \text{Vs} / 10000$
	AV Trace VMean	cm/s	Refer to M speed meas.
	AV Trace MPG	mmHg	Formula: $\text{MPG} = 4 \times \text{VMean} \times \text{VMean} / 10000$
	AV Vmax Velocity	cm/s	Refer to M speed meas.
	AV Vmax Pressure	mmHg	Formula: Pressure = $4 \times \text{Velocity} \times \text{Velocity} / 10000$
	AV PHT VPeak	cm/s	Refer to M speed meas.
	AV PHT Pressure	mmHg	Formula: Pressure = $4 \times \text{VPeak} \times \text{VPeak} / 10000$
	AV PHT Slope	cm/s <sup>2</sup>	
	AV PHT	s	
	AV PHT Area	cm <sup>2</sup>	Formula: $220 / \text{AV PHT}$
	R-R interval	bpm	

Meas. Menu	Submenu	Unit	Meas. Method/ Meas. Formula
	AR Trace Vs	cm/s	Refer to M speed meas.
	AR Trace PPG	mmHg	Formula: $PPG = 4 \times Vs \times Vs / 10000$
	AR Trace VMean	cm/s	Refer to M speed meas.
	AR Trace MPG	mmHg	Formula: $MPG = 4 \times VMean \times VMean / 10000$
	AR Vmax Velocity	cm/s	Refer to M speed meas.
	AR Vmax Pressure	mmHg	Formula: Pressure = $4 \times Velocity \times Velocity / 10000$
	AR PHT VPeak	cm/s	Refer to M speed meas.
	AR PHT Pressure	mmHg	Formula: Pressure = $4 \times VPeak \times VPeak / 10000$
	AR PHT Slope	cm/s <sup>2</sup>	
	AR PHT	s	
	AR PHT Area	cm <sup>2</sup>	Formula: $220 / AV \text{ PHT}$
MV	EPeak	cm/s	Refer to M speed meas.
	EPeak Pressure	mmHg	Formula: Pressure = $4 \times EPeak \times EPeak / 10000$
	APeak	cm/s	Refer to M speed meas.
	APeak Pressure	mmHg	Formula: Pressure = $4 \times APeak \times APeak / 10000$
	E/A	%	Formula: $EPeak / APeak * 100$
	MV VPeak	cm/s	Refer to M speed meas.
	MV PHT Pressure	mmHg	Formula: Pressure = $4 \times VPeak \times VPeak / 10000$
	MV PHT Slope	cm/s <sup>2</sup>	
	MV PHT	s	
	MV PHT Area	cm <sup>2</sup>	Formula: $220 / MV \text{ PHT}$
	E Dur	s	Refer to M time meas.
	A Dur	s	Refer to M time meas.
	IRT	s	Refer to M time meas.
	MV Diam	cm	Refer to B distance meas.
	MV Area	cm <sup>2</sup>	Refer to B trace meas.
	MV Trace Vs	cm/s	Refer to M speed meas.
	MV Trace PPG	mmHg	Formula: $PPG = 4 \times Vs \times Vs / 10000$
	MV Trace VMean	cm/s	Refer to M speed meas.
	MV Trace MPG	mmHg	Formula: $MPG = 4 \times VMean \times VMean / 10000$
	MV Trace TVI	cm	
	Time	s	Refer to M time meas.
	MV Trace HR	bpm	Formula: $60 / Time$
	MV Trace SV	ml	Formula: $0.785 * Diam * Diam *  TVI $
	MV Trace CO	l/min	Formula: $SV * HR(\text{Single wave}) / 1000$
R-R interval	bpm		

Meas. Menu	Submenu	Unit	Meas. Method/ Meas. Formula
	MR Vmax	cm/s	Refer to M speed meas.
	MR Vmax Pressure	mmHg	Formula:Pressure = $4 \times V_{max} \times V_{max} / 10000$
	MR TVI	cm	
TV	TV Manual Trace Vs	cm/s	Refer to M speed meas.
	TV Manual Trace PPG	mmHg	Formula:PPG = $4 \times V_s \times V_s / 10000$
	TV Manual Trace VMean	cm/s	Refer to M speed meas.
	TV Manual Trace MPG	mmHg	Formula:MPG = $4 \times V_{Mean} \times V_{Mean} / 10000$
	TV Manual Trace TVI	cm	
	TV PHT VPeak	cm/s	Refer to M speed meas.
	TV PHT Pressure	mmHg	Formula:PPG = $4 \times V_{Peak} \times V_{Peak} / 10000$
	TV PHT Slope	cm/s <sup>2</sup>	
	TV PHT	s	
	TV PHT Area	cm <sup>2</sup>	Formula:220/ TV PHT
	R-R interval	bpm	
	TR Manual Trace Vs	cm/s	Refer to M speed meas.
	TR Manual Trace PPG	mmHg	Formula:PPG = $4 \times V_s \times V_s / 10000$
	TR Manual Trace VMean	cm/s	Refer to M speed meas.
	TR Manual Trace MPG	mmHg	Formula:MPG = $4 \times V_{Mean} \times V_{Mean} / 10000$
	TR Manual Trace TVI	cm	
	TR Vmax	cm/s	Refer to M speed meas.
	TR Vmax Pressure	mmHg	Formula:Pressure = $4 \times V_{max} \times V_{max} / 10000$
	TR TVI	cm	
	PV	InFlow Velocity	cm/s
InFlow Pressure		mmHg	Formula:Pressure = $4 \times Velocity \times Velocity / 10000$
PV Diam		cm	Refer to B distance meas.
PV Trace Vs		cm/s	Refer to M speed meas.
PV Trace PPG		mmHg	Formula:PPG = $4 \times V_s \times V_s / 10000$
PV Trace VMean		cm/s	Refer to M speed meas.

Meas. Menu	Submenu	Unit	Meas. Method/ Meas. Formula
	PV Trace MPG	mmHg	Formula: $MPG = 4 \times V_{Mean} \times V_{Mean} / 10000$
	PV Trace TVI	cm	
	Time	s	
	PV Trace HR	bpm	Formula: $60 / \text{Time}$
	PV Trace SV	ml	Formula: $0.785 \times \text{Diam} \times \text{Diam} \times  \text{TVI} $
	PV Trace CO	l/min	Formula: $SV \times \text{HR} (\text{Single wave}) / 1000$
	RV ET	s	Refer to M time meas.
	RV AcT	s	Refer to M time meas.
	RV AcT/ET		Formula: $\text{AcT} / \text{ET}$
	RV REP	s	Refer to M time meas.
	RV STI		Formula: $\text{REP} / \text{ET}$
	PV PHT VPeak	cm/s	Refer to M speed meas.
	PV PHT Pressure	mmHg	Formula: $\text{PPG} = 4 \times V_{Peak} \times V_{Peak} / 10000$
	PV PHT Slope	$\text{cm/s}^2$	
	PV PHT	s	
	PV PHT Area	$\text{cm}^2$	Formula: $220 / \text{TV PHT}$
	R-R interval	bpm	
	PR Vmax	cm/s	Refer to M speed meas.
	PR Vmax Pressure	mmHg	Formula: $\text{Pressure} = 4 \times V_{max} \times V_{max} / 10000$
Pul. Vein	Pul. Vein Vs	cm/s	Refer to M speed meas.
	Pul. Vein Vd	cm/s	Refer to M speed meas.
	Pul. Vein SD		Formula: $\text{SD} = V_s / V_d$
	ARV	cm/s	Refer to M speed meas.
	ARD	s	Refer to M time meas.

## 6.29 PW Vascular Measurement

Press [**Calc**] to enter PW measurement in PW vascular mode. Or press the corresponding parameter control key to switch the vascular measurement item.

Meas. Menu	Submenu	Unit	Meas. Method/ Meas. Formula
------------	---------	------	--------------------------------

Meas. Menu	Submenu	Unit	Meas. Method/ Meas. Formula
Subclavian A Prox CCA Mid CCA Distal CCA Bulb Prox ICA Mid ICA Distal ICA ECA Vertebral A	Vs	cm/s	Refer to M speed meas.
	Pressure(s)	mmHg	Formula:Pressure=4xVsxVs/10000
	Vd	cm/s	Refer to M speed meas.
	Pressure(d)	mmHg	Formula:Pressure=4xVdxVd/10000
	VMean	cm/s	Refer to M speed meas.
	Pressure(VMean)	mmHg	Formula:Pressure=4xVMeanxVMean/10000
	TVI	cm	
	SD		Formula:SD=Vs/Vd
	RI		Formula:SD=(Vs-Vd)/Vs
	PI		Formula:SD=(Vs-Vd)/VMean
	HR(Single wave)	bpm	

### 6.30 PW Urology Measurement

Refer to PW general measurement.

### 6.31 PW Small parts Measurement

Refer to PW general measurement.

### 6.32 PW Pediatric Measurement

Refer to PW general measurement.

# Chapter 7 Preset

This chapter introduces the operation to make settings of the system through preset menu at preset mode.

Preset function is used to set up working environment and status, parameters of each examination mode. The setting will be stored in the memory of system and not be lost even after the system is switched off. When the system is switched on, it will work automatically with the status which is required by the operator.

In preset interface, all operation relies on moving trackball to required Function button position. Press [ENTER] to start operation.

## 7.1 General setting

### 7.1.1 General Interface

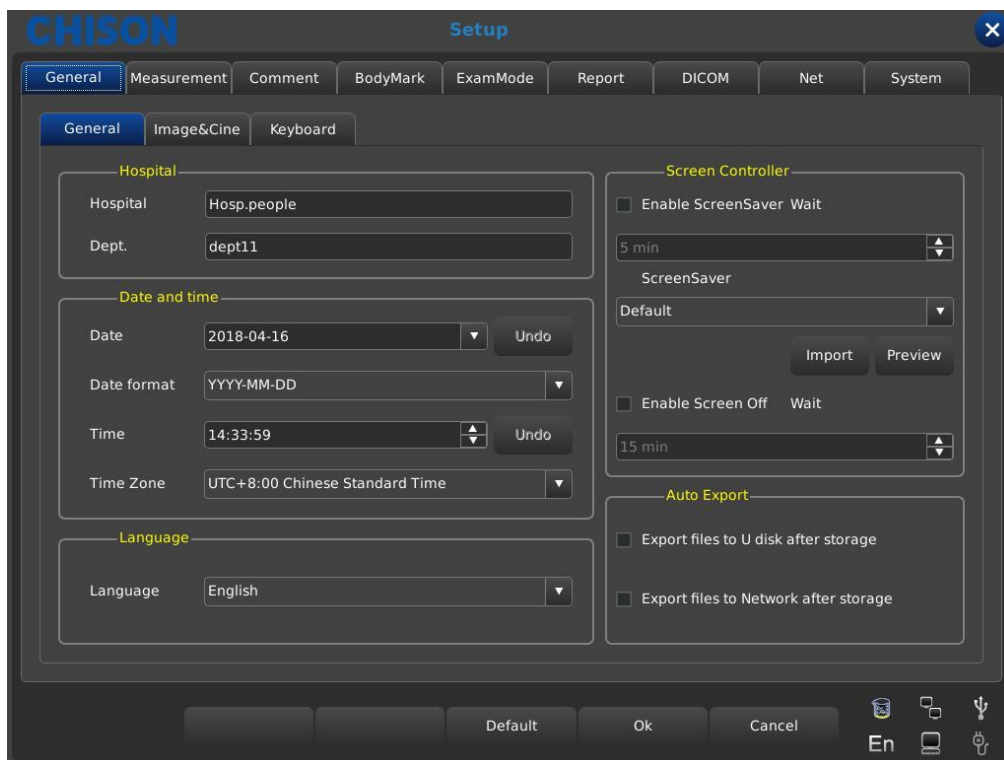

Press the [SETUP] to enter system setting interface. User can do user-defined setting.

Click [X] in the title bar or the exit key on the button can exit the system setting interface.

Function name	Setting method	Function description
Hospital, Department	Input freely	Set up the hospital name which is shown at top left corner of "General Setting" dialog box, 20 characters Max can be input.
Date and Time	Input freely	Set up the system date (calendar format), select current date directly. Date format can be changed by format setting.
Date Format	Set up freely	Set up date format: Year/Month/Date, Month/Date/Year, Date/Month/Year.
Time zone	Set up freely	Set up the working clock of the system.
Screen Controller	Select the function and set its start time	Enable screen saver, user can custom screen saver images, a custom picture named "screensaver", JPG, PNG, BMP format, size does not exceed 512 * 384 pixels.
Language	Select language	Select the language of operation interface(Simplified Chinese English and so on)
Auto Export	Select the need option	Select to export files to U disk or Network after storage.
Default	Press button	Recover all preset to factory setting.

## 7.1.2 Image & Cine setting

User can select Image&Cine option to set the screen type, parameters of image, cine or image area. See the following sheet 2 for detailed description.

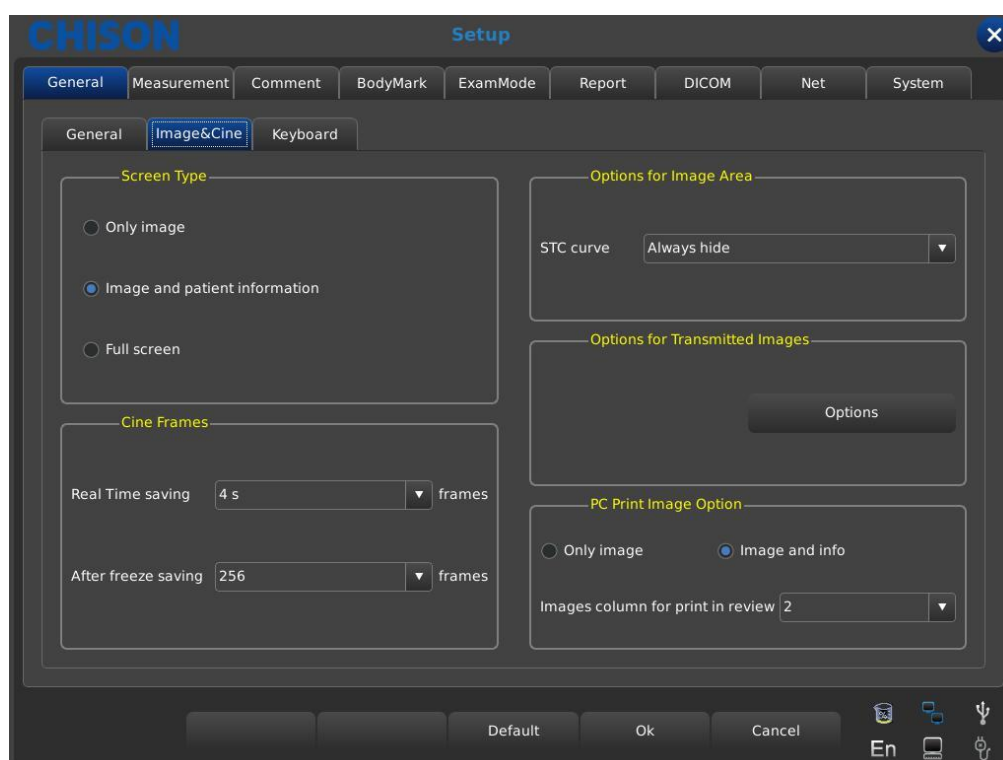

Function name	Setting method	Function description
Screen Type	Select the need type	Set the content which screen picture contain: only picture, image and patient information, full screen.
Cine Frames	Select the parameter	Set the default frame or time when saving the film.
Options for Image Area	Click the button to open the setting box	Set the STC curve, including always shows, always hide and hide for 1 to 8 seconds.
Options for Transmitted Images	Click the button to open the setting box	Adjust the parameters of transmitted images: brightness, contrast, and gamma and select the need image type.
PC Print Image Option	Select the need option	Including print area and arrangement condition in the image foresee interface.

### 7.1.3 Keyboard setting

Users can set the different functions for number keys and other optional buttons according to the using habits.

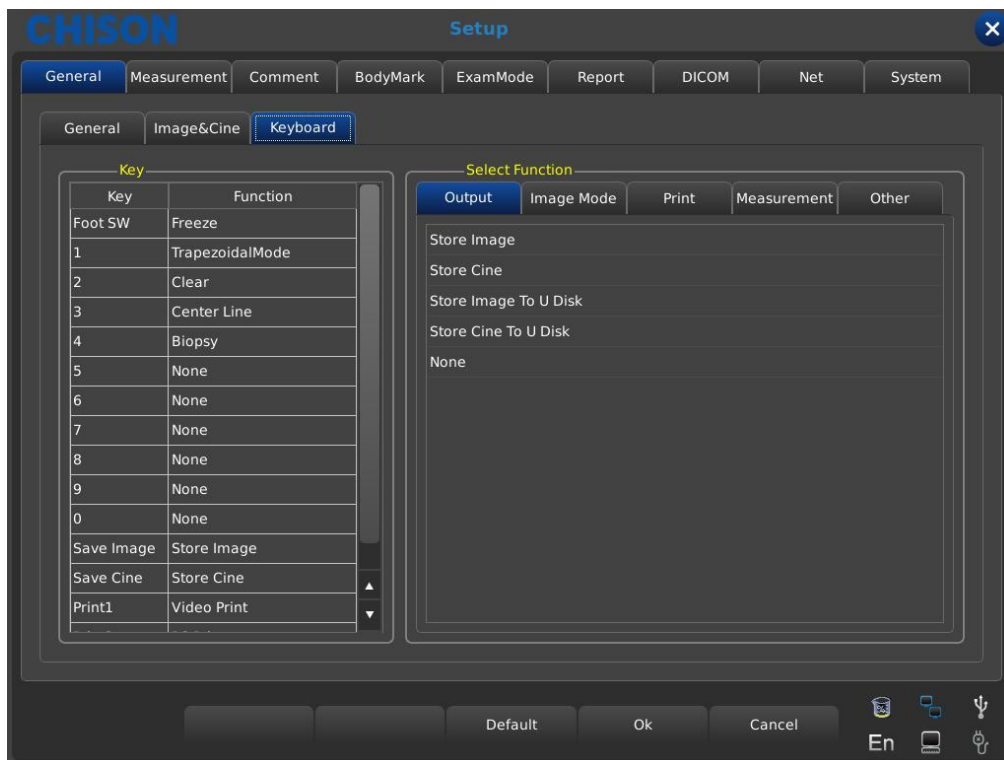

- **Key:** display the settable number keys and buttons and selected function.
- **Output:** including store images, store films, store images to U disk, store film to U disk, etc. function options.
- **Image mode:** including image full screen, biopsy, chroma, etc.
- **Print:** including video print, pc print etc.



- **Measurement:** including GS, CR, BPD, HC, AC, etc.
- **Other:** including arrow, archive.

## 7.2 Measurement

Measurement includes general measurement setting and measurement formula setting.

### 7.2.1 General measurement setting

General settings can only change the display of measurement unit.

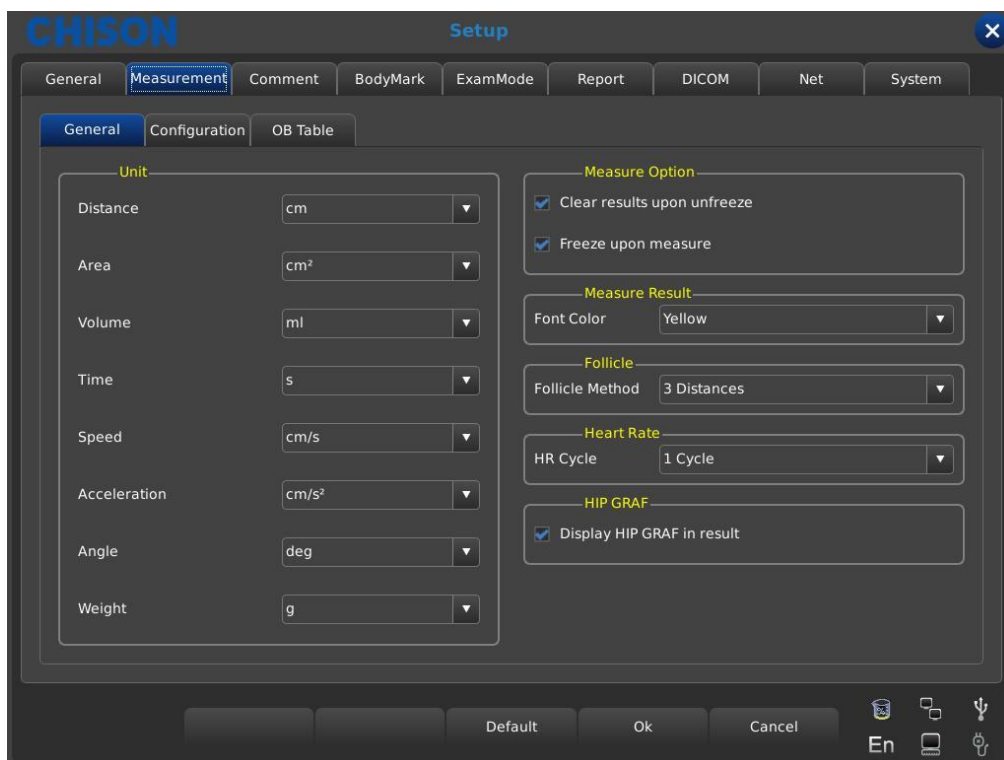

- **Distance:** cm, mm
- **Area:** cm<sup>2</sup>, mm<sup>2</sup>
- **Volume:** ml, l
- **Time:** s, ms
- **Speed:** cm/s, mm/s
- **Acceleration:** cm/s<sup>2</sup>, mm/s<sup>2</sup>
- **Angle:** deg, rad
- **Weight:** g, kg
- **Measure Option:** whether clear results upon unfreeze, and the automatic froze image.
- **Measure Result:** the color of the result font is alternative, including yellow/white/orange/green.
- **Follicle:** ways to measure follicle, you can choose two distances and three distances.

- **Heart Rate:** select heart rate cycle, optional range is 1 cycle~6 cycles.
- **HIP GRAF:** select to display HIP GRAF in result or not.

## 7.2.2 Measurement formula setting

### 7.2.2.1 Interface Description-Measurement Menu

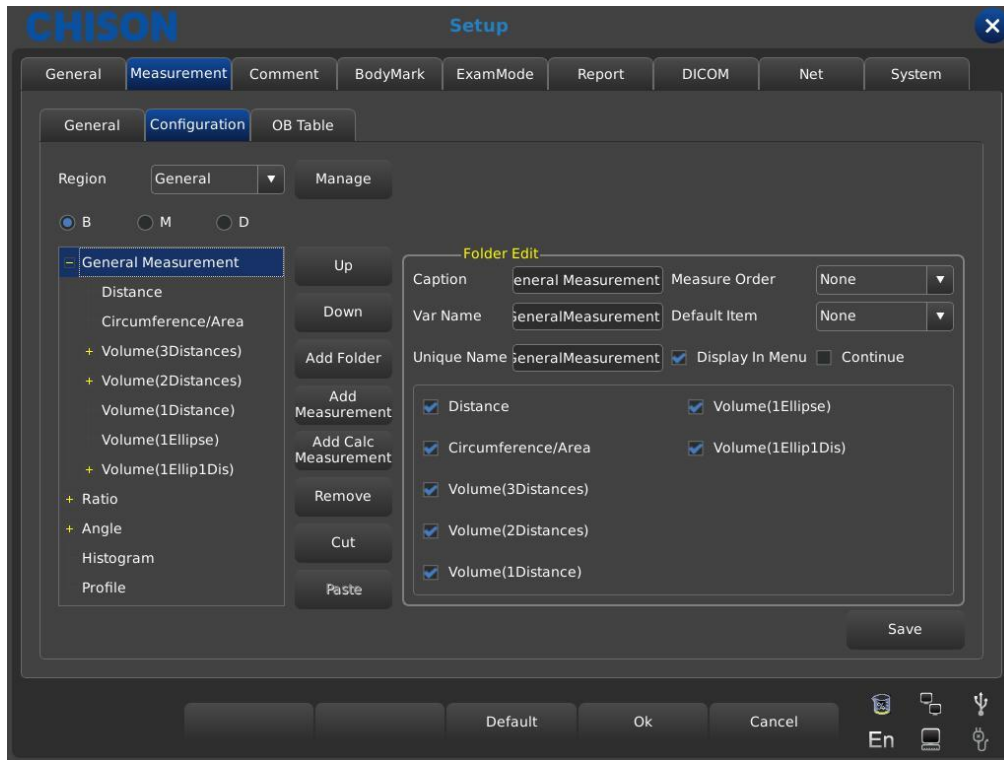

- **Region:** pull down and select needed measurement menu.
- **Manage:** pop up measurement software edition interface, add modify delete change marshalling sequence in measurement menu.
- **B, M, D:** display measurement of each Exam mode.
- **Up:** press this button to move selected measurement term up.
- **Down:** press this button to move selected measurement term down.
- **Add Folder:** add a measurement item. In the left column when the term is fold there is "+" otherwise "-".
- **Add Measurement:** add a measurement item for a term in the right column there is selected item and detailed parameter.
- **Add Calc Measurement:** add a calc item for a measurement term.
- **Remove:** remove selected measurement term or item.
- **Cut:** select to cut the measurement option you want to paste.

- **Paste:** paste the measurement option you have cut.

Folder Edit content description

<b>Caption</b>	Display names of all items that is displayed name in measurement menu
<b>Var Name</b>	The name of built-in selected measurement menu, user don't need modify while display order according to the names
<b>Unique Name</b>	Built-in code, user don't need modify
<b>Measurement rule</b>	None: Disable rule, Repeat: Repeat this item , Sequential: measure by sequence
<b>Default item</b>	After choosing the Repeat and Sequential, choose one measurement or calculation to activate the measurement rule

### 7.2.2.2 Interface Description-Measurement Manipulation

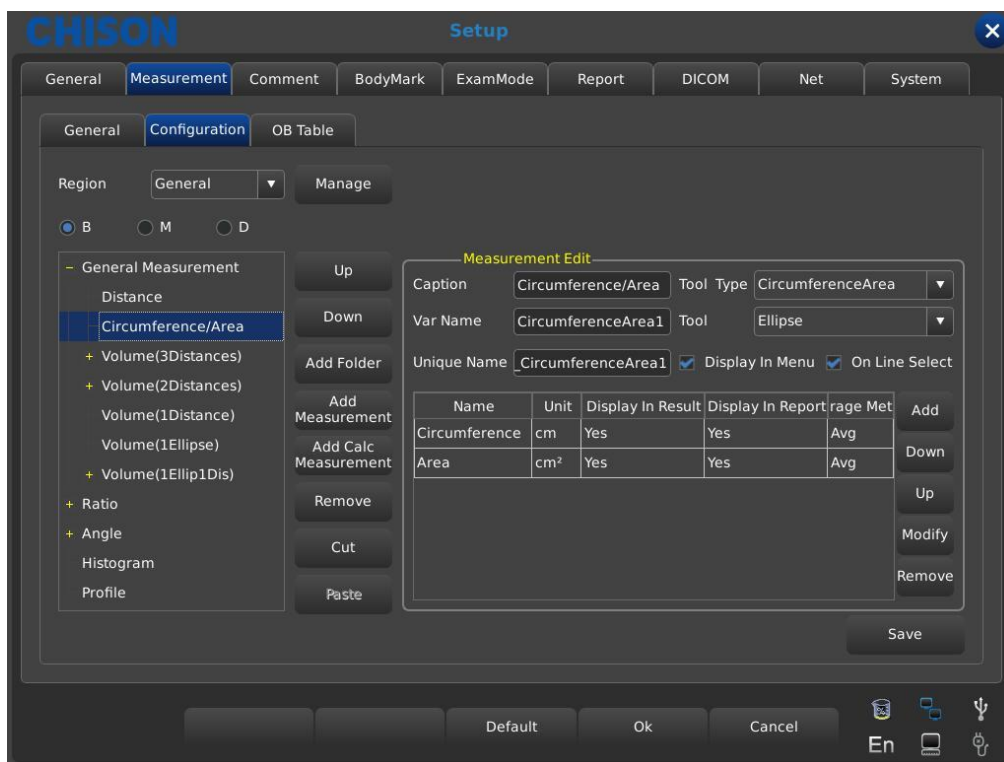

Measurement Edit content description

<b>Caption</b>	Display the name of selected term that is display names in the measurement menu
<b>Var Name</b>	The name of built-in selected measurement menu, user don't need modify while display order according to the names

<b>Unique Name</b>	Built-in code, user don't need modify
<b>Display In Menu</b>	Check the required item and it will display on the measurement menu. The item without checking will not display on the measurement menu.
<b>Choose measurement methods</b>	Check the methods in measurement menu , press [update] to switch the method, Otherwise , the measurement is not available
<b>Display in Report</b>	Check and display the item in measurement menu , otherwise ,the item is not displayed
<b>Name</b>	Measurement operation of specific measurement display in results
<b>Unit</b>	Data unit which measurement operation produces
<b>Display In Report</b>	Whether display in the report or not.
<b>Average Method</b>	The average rule of data
<b>Modify</b>	Press this button to pop up interface to modify measurement operation
<b>Remove</b>	Press this button to delete selected measurement operation

### 7.2.2.3 Interface Description-Measurement Calculation

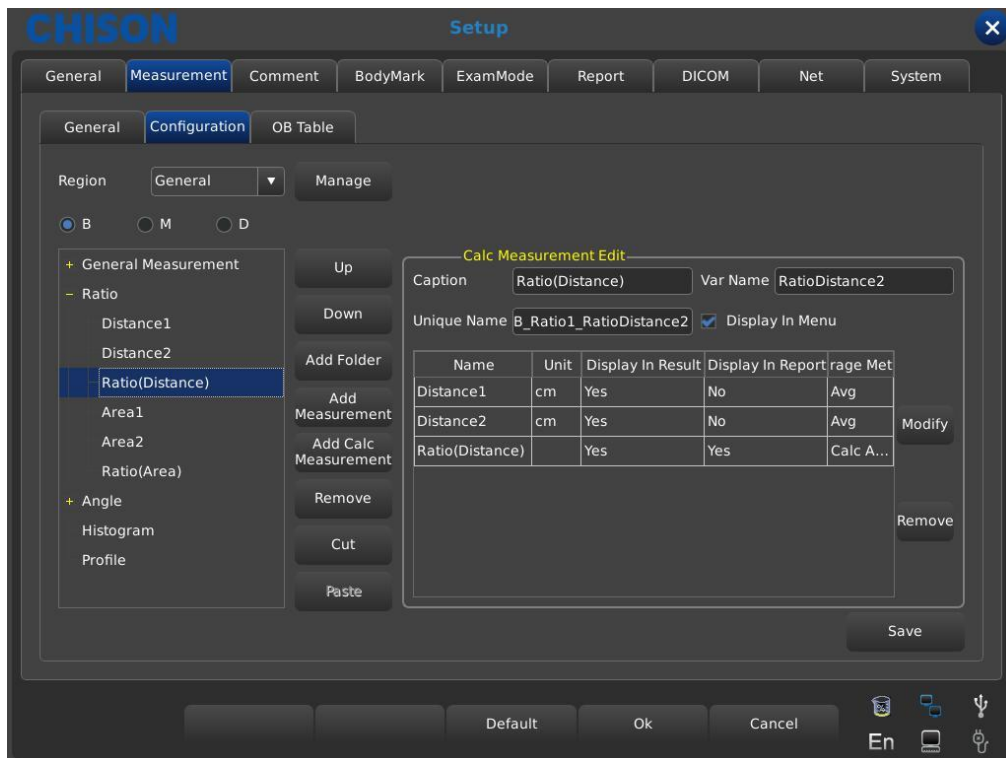

Calc Measurement Edit content description

<b>Caption</b>	Display the name of selected term that is display names in the measurement menu
<b>Var Name</b>	The name of built-in selected measurement menu, user don't need modify while display order according to the names
<b>Unique Name</b>	Built-in code, user don't need modify
<b>Tool Type/Tool</b>	Select available measurement tool type B distance (B line),area/circumference(ellipse, trace), M distance(M vertical line), time(M horizontal line), M slope(M slant)
<b>Name</b>	Needed measurement operation of specific measurement and calculation
<b>Unit</b>	Data unit which measurement operation produces
<b>Display In Report</b>	Whether display in the report or not.
<b>Up</b>	Press this button to move measurement operation up
<b>Down</b>	Press this button to move measurement operation down
<b>Average Method</b>	The average rule of data
<b>Add</b>	Press this button to pop up interface to add measurement operation
<b>Modify</b>	Press this button to pop up interface to modify measurement operation
<b>Remove</b>	Press this button to delete selected measurement operation

#### 7.2.2.4 Create Measurement Operation

Press [**Add**] in measurement operation interface, pop up the following dialog box.

Operation content description of creating new measurement

<b>Caption</b>	Display the name of selected term that is display names in the measurement menu
<b>Var Name</b>	The name of built-in selected measurement menu, user don't need modify while display order according to the names
<b>Unique Name</b>	Built-in code, user don't need modify
<b>Ruler Result</b>	Needed measurement operation of specific measurement and calculation
<b>Edit</b>	Enter into interface to edit formula when selecting calculation item
<b>Maximum</b>	The maximum value displays in result zone and report
<b>Minimum</b>	The minimum value displays in result zone and report
<b>Unit</b>	Data unit which measurement operation produces
<b>Display In Report</b>	Whether display in the report or not.
<b>Method</b>	The average rule of data

#### 7.2.2.5 Formula Edit-Normal

It is necessary to enter into the following interface when creating measurement operation except OB.

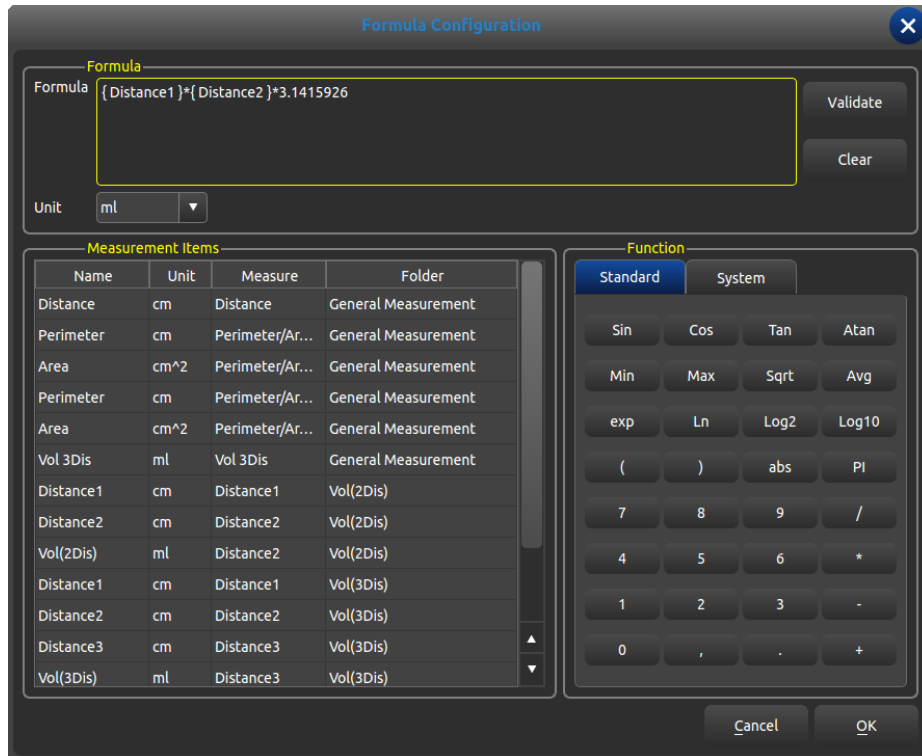

- **Formula:** edit formula in input box via keyboard and built-in formula.
- **Validate:** press this button to check whether the formula is right or not after editing formula.
- **Clear:** clear the content in the input box.
- **Unit:** select the unit of calculation consequence.
- **Measurement Items:** display all available measurement operation in the measurement menu.
- **Function:** built-in formula, number input and some parameters that system needs such as BSA, SPSA etc.
- **Cancel:** cancel editing formula and close the interface.
- **OK:** save edited operation and close the interface.

### 7.2.2.6 Formula Edit-OB

It is necessary to call built-in OB formula sheet when creating OB measurement operation the following function interface is required.

**⚠ CAUTION:** *the results of GA and EDD don't require unit, the unit of this class has been built-in.*

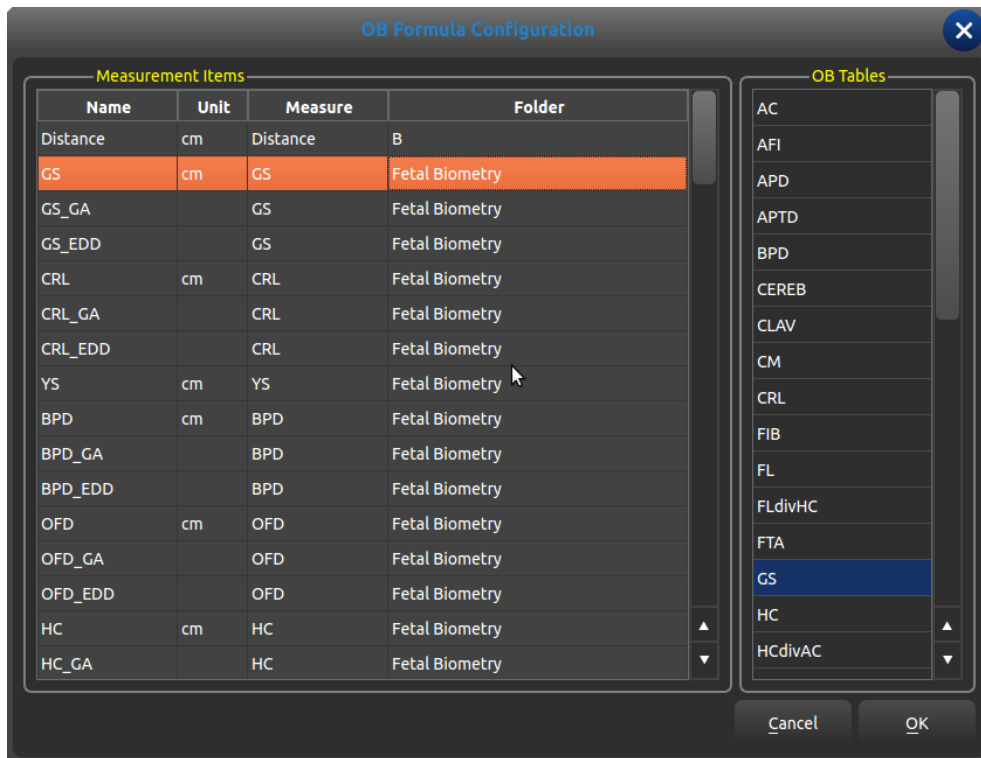

**Measurement Items:** display created measurement term by now

**OB Tables:** built-in OB formula table

OB List

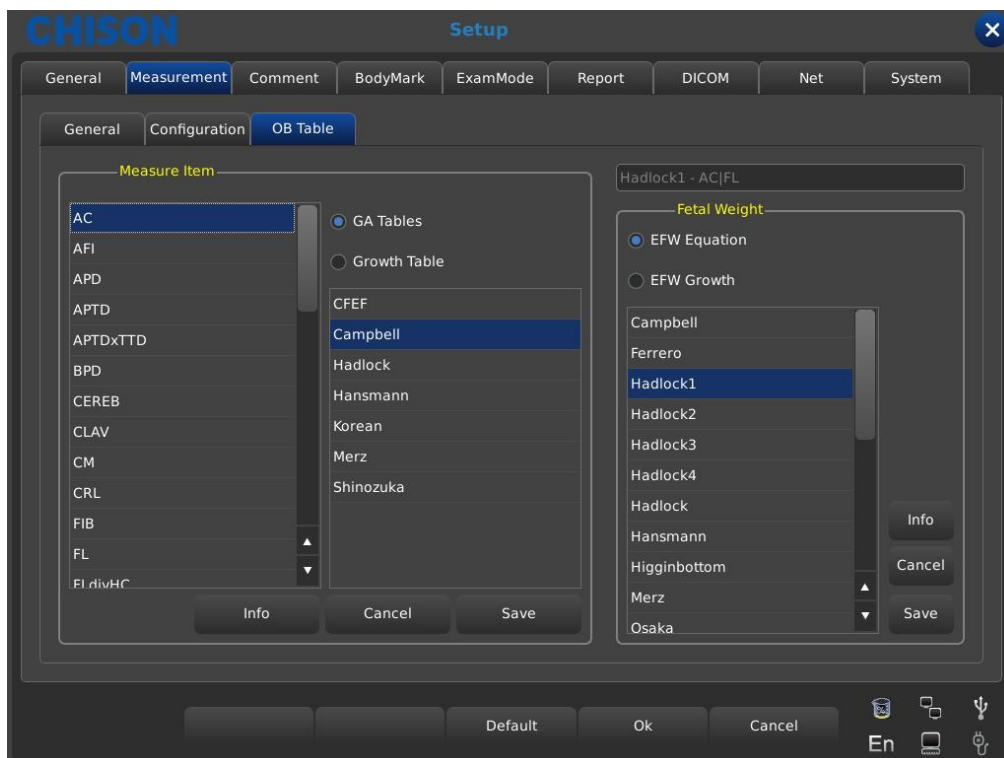

- **Measure Item:** OB Measurement Item.
- **GA Tables:** Gestational list for the current measuring project.



- **Growth Table:** Growth table for the current measuring.
- **Fetal Weight:** Fetal Weight calculation formula.
- **EFW Equation:** Fetal weight calculation for the current measuring.
- **EFW Growth:** Fetal weight growth curve for the current measuring.
- **Info:** Display the gestational age and fetal weight for the current measuring.
- **Cancel:** Cancel the operation of choosing the formula.
- **Save:** Save the users' choice of formulas.

## 7.3 Comment

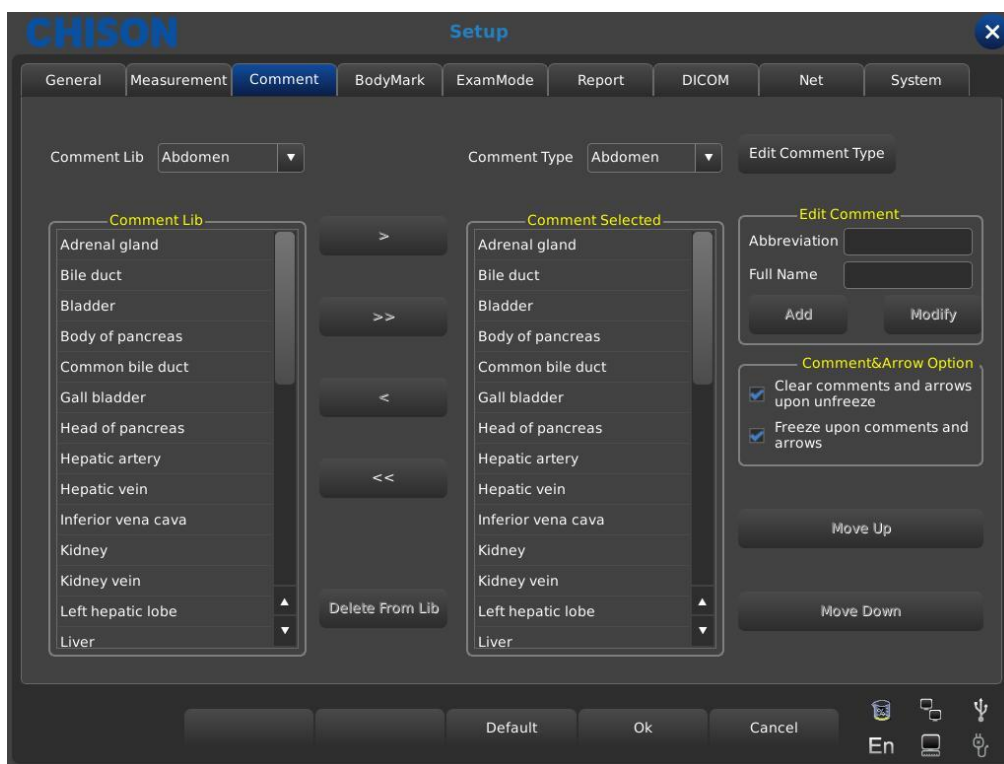

### 7.3.1 Comment Library

The annotation database of the system is classified as: Abdomen, OB, GYN, Cardiac, Small part, Pathological change Annotation can be made by inputting characters from the soft keyboard or recalling the terms saved in annotation database.

Press [**Comment Lib**] pull down button, pop up annotation name within system, through trackball and [**ENTER**] to show required annotation status.

#### 7.3.1.1 Edit Comment Library

Operation:

1. At the annotation status, Move the cursor to the **[Edit Comment Type]** button then press **[ENTER]**; the annotation will be updated, and can be edited.
2. Input name into the new created annotation status box, move the cursor to the **[Create]** button then press **[ENTER]**, then create new annotation status and appear in selected annotation status list.
3. Move the cursor to the **[Delete]** button, press **[ENTER]**, then delete current annotation status in the selected annotation list.
4. Alter name of current annotation status list in **[Current Type Name]** input box, press **[ENTER]** on the **[Rename]** button, then rename the selected annotation status name.

### **NOTE:**

*Factory Settings comments cannot be deleted or renamed.*

## **7.3.2 Edit Comment**

Operator uses only current annotation instead of all content annotation status provides inlay common annotation. If necessary, user can import annotation or self-compiled annotation into common annotation.

### **7.3.2.1 Add comment from comment library**

Operation:

1. Select needed source annotation status via Trackball and **[ENTER]**.
2. Select needed annotation at **[Comment Lib]** column then press **[ENTER]** to activate this annotation.
3. Press **[ENTER]** on **[>]** button to import selected annotation into user-selected annotation status; press **[ENTER]** on **[>]** button to move selected annotation in **[Comment Selected]** column into source annotation.
4. Press **[ENTER]** on **[>>]** button to import all annotation in source into user-selected annotation status; Press **[ENTER]** on **[>>]** button to move all annotation in **[Comment Selected]** column into source annotation.

### **7.3.2.2 Add comment manually**

Operation:

1. Activate [**Edit Comment**] input box via Trackball and [**ENTER**] button, and then input needed abbreviation and full name of annotation.
2. Press [**ENTER**] on [**Add**] button, meanwhile this handout will be added into source and user-selected annotation status.

### **7.3.2.3 Alter comment**

Operation:

1. Alter annotation in user-selected status, the abbreviation and full name of annotation will be displayed in [**Edit Comment**] box.
2. Activate needed abbreviation and full name via [**ENTER**] and alter via keyboard.
3. Press [**ENTER**] on [**Modify**] button, modify the annotation in both source and user-selected status.

### **7.3.2.4 Delete comment in library**

Operation:

Select needed annotation in source status, press [**ENTER**] on [**Delete from Lib**] button then the annotation deleted.

### **7.3.3 Comment and Arrow Option**

Optional: whether clear comments and arrows upon unfreeze.

Optional: whether freeze upon comments and arrows.

## 7.4 Body marks

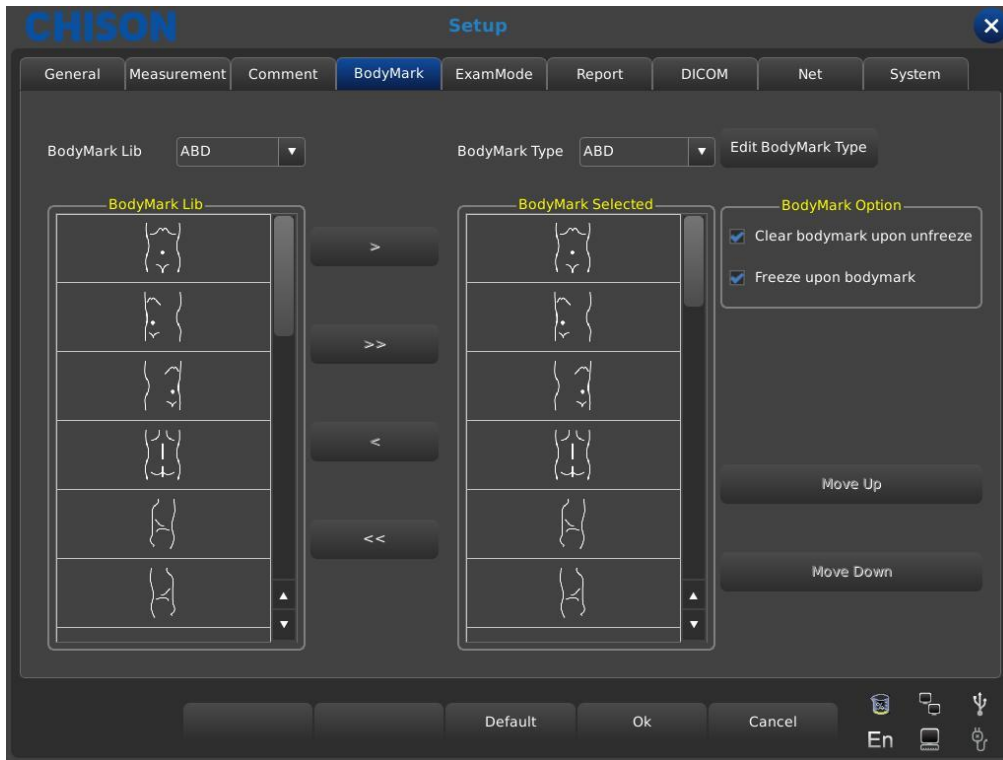

### 7.4.1 Body Marks Library

Built-in body marks: Abdomen, OB, GYN, Cardiac, Small part, Urology, Vessel.

Press [**BodyMark Lib**] pull down button, pop up name of built-in body marks, show needed body marks via Trackball and [**ENTER**] button.

#### 7.4.1.1 Edit body marks library

Operation:

1. Press [**ENTER**] on [**Edit BodyMark Type**], pop edit box.
2. Input name into the new created body marks box, Move the cursor to the [**Create**] button then press [**ENTER**], then the new body marks will be created and appear in selected body marks list.
3. Move the cursor to the [**Delete**] button then press [**ENTER**], and then delete current body marks in the selected list.
4. Alter current annotation status list name in [**Current Type Name**] input box, press [**ENTER**] on the [**Rename**] button, then rename the selected body marks.

## 7.4.2 Body mark edition

Operation:

1. Select needed source body marks via Trackball and **[ENTER]**.
2. Select needed body marks at **[BodyMarkLib]** column then press the **[ENTER]** button to activate it.
3. Press **[ENTER]** on **[>]** button to import selected body marks into user-selected status; press **[ENTER]** on **[>]** button to move selected body marks in **[BodyMark Selected]** column into source body marks.
4. Press **[ENTER]** on **[>>]** button to import all body marks in source into user-selected status; press **[ENTER]** on **[>>]** button to move all body marks in **[BodyMarks Selected]** column into source.
5. Press **[ENTER]** on **[Move UP]** button to move up the selected body mark; Press **[ENTER]** on **[Move Down]** button to move down the selected body mark.

## 7.4.3 Body mark Option

Optional: whether clear bodymark upon unfreeze.

Optional: whether freeze upon bodymark.

## 7.5 Exam Mode

### 7.5.1 Exam Mode Edit

Press Utility in the submenu of **[MENU]**, the parameters control area shows as following. Press the corresponding control button to turn on or off the function.

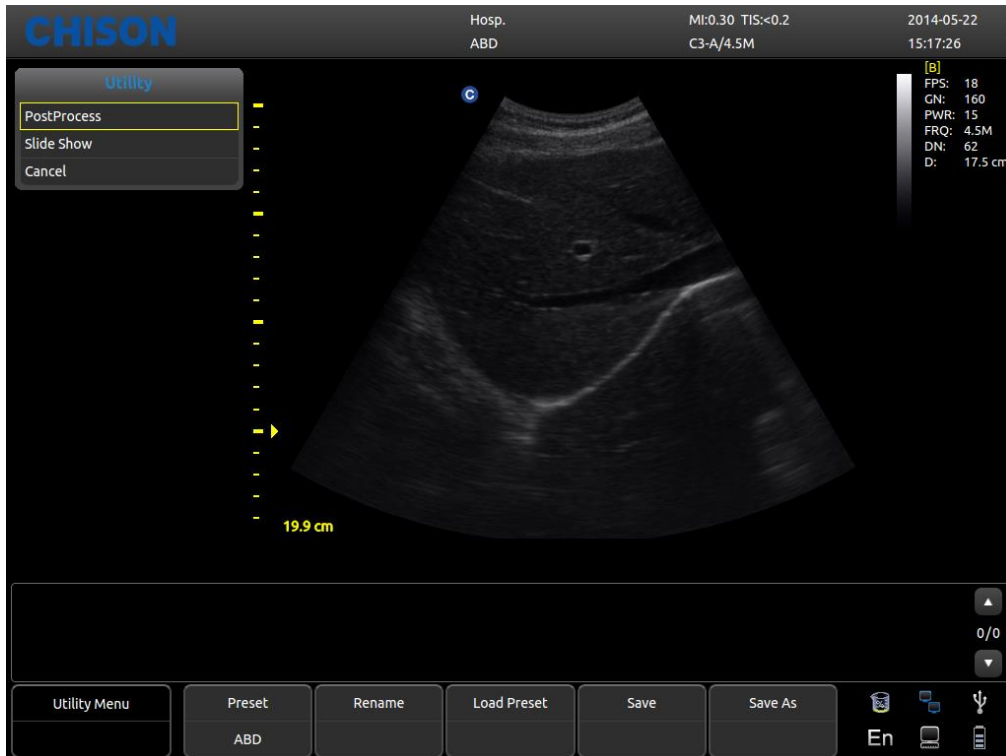

- **Preset:** Display the current preset.
- **Rename:** Rename the current preset.
- **Load Preset:** Load the preset displayed.
- **Save:** Save the current preset.
- **Save As:** Save the current preset as others.

## 7.5.2 Exam Mode Selection

Choose Utility and press [MENU], the following interface pops up. Open the relate function by corresponding control area.

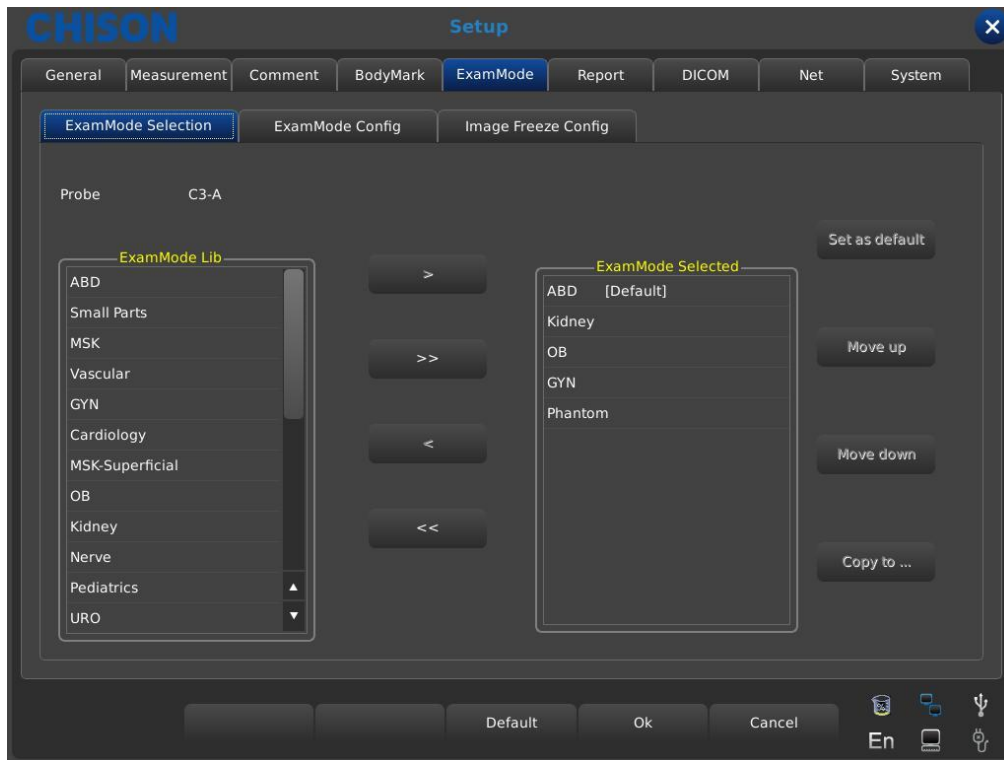

- **Probe:** select needed probe and ExamMode fit for it.
- **ExamMode Lib:** show all existed Exam modes.
- **ExamMode Selected:** show Exam modes in probe column.
- **>:** import selected Exam modes from ExamModeLib column to ExamMode Selected column.
- **>>:** import all Exam modes from ExamModeLib column into ExamMode Selected column.
- **<:** delete selected Exam modes in ExamMode Selected column.
- **<<:** delete all Exam modes in ExamMode Selected column.
- **Set as default:** set selected Exam modes in ExamMode Selected column as default.
- **Move up:** move selected Exam modes in ExamMode Selected column up.
- **Move down:** move selected Exam modes ExamMode Selected column down.
- **Copy to:** copy the exam mode selected in ExamMode to a specified preset.

### 7.5.3 ExamMode config

Operator can define needed Exam mode in detail including annotation, body marks, measurement menu import and export etc.

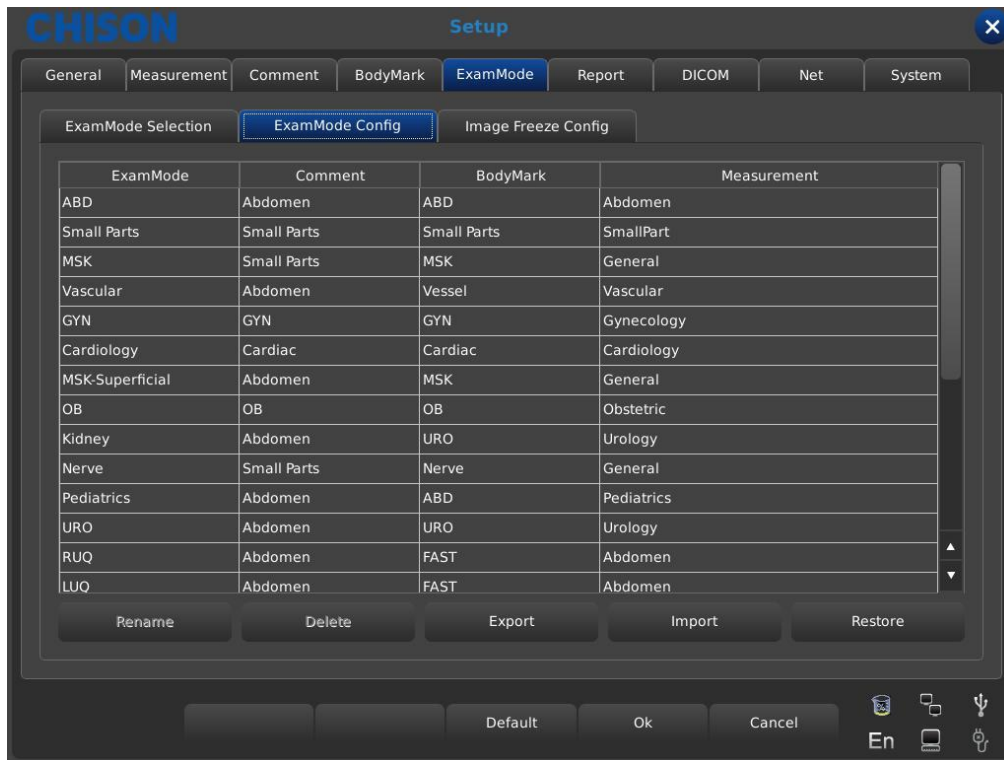

- **ExamMode:** show all existed Exam modes in system.
- **Comment:** double press [ENTER] to activate widget box, can choose existed annotation status name. After setting, the default of the Exam mode is user-selected.
- **BodyMark:** same as Comment, select user-needed default body marks.
- **Measurement:** same as Comment, select user-needed default measurement menu.
- **Rename:** rename selected Exam mode.
- **Delete:** delete selected Exam mode.
- **Export:** export all built-in Exam modes into USB flash disk.
- **Import:** import all built-in Exam modes into USB flash disk.
- **Restore:** restore all Exam mode as factory setting.

### 7.5.4 Image Freeze Config

Operator can be set to quickly enter the following statuses when the image is frozen, including cine, body mark, comment, trace, distance and calc.



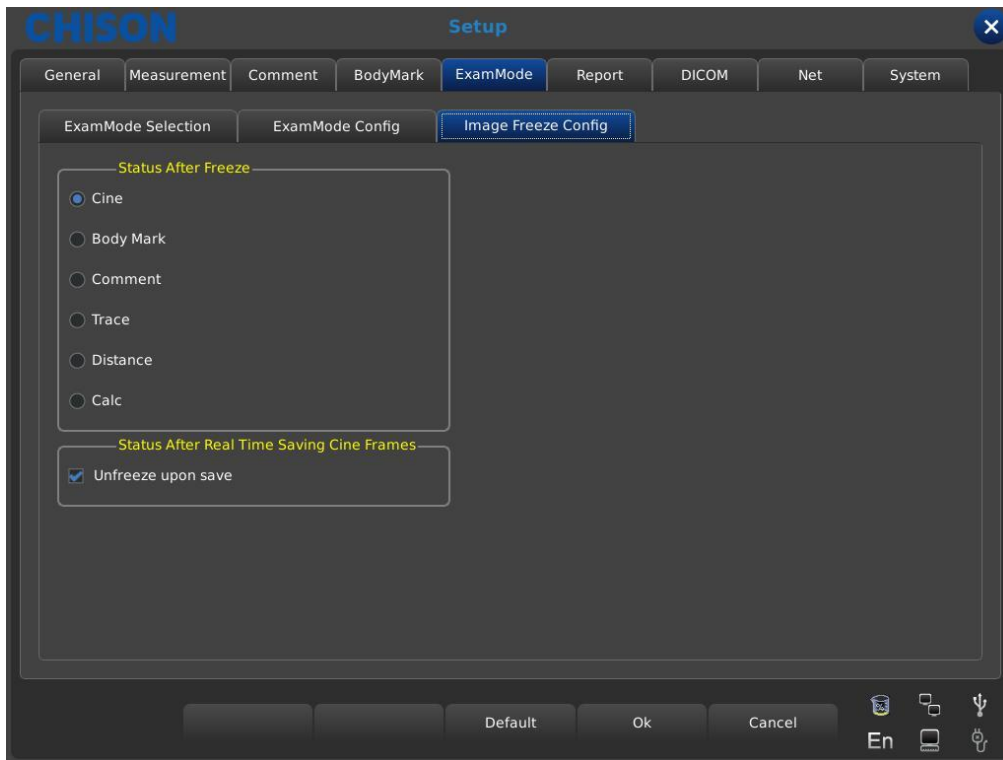

- **Status After Freeze:** options for status after freezing.
- **Status After Real Time saving Cine Frames:** whether unfreezing upon save or not.

## 7.6 Report

Users can set the layout and diagnostic template for report according to the requirement.

### 7.6.1 Layout Setting

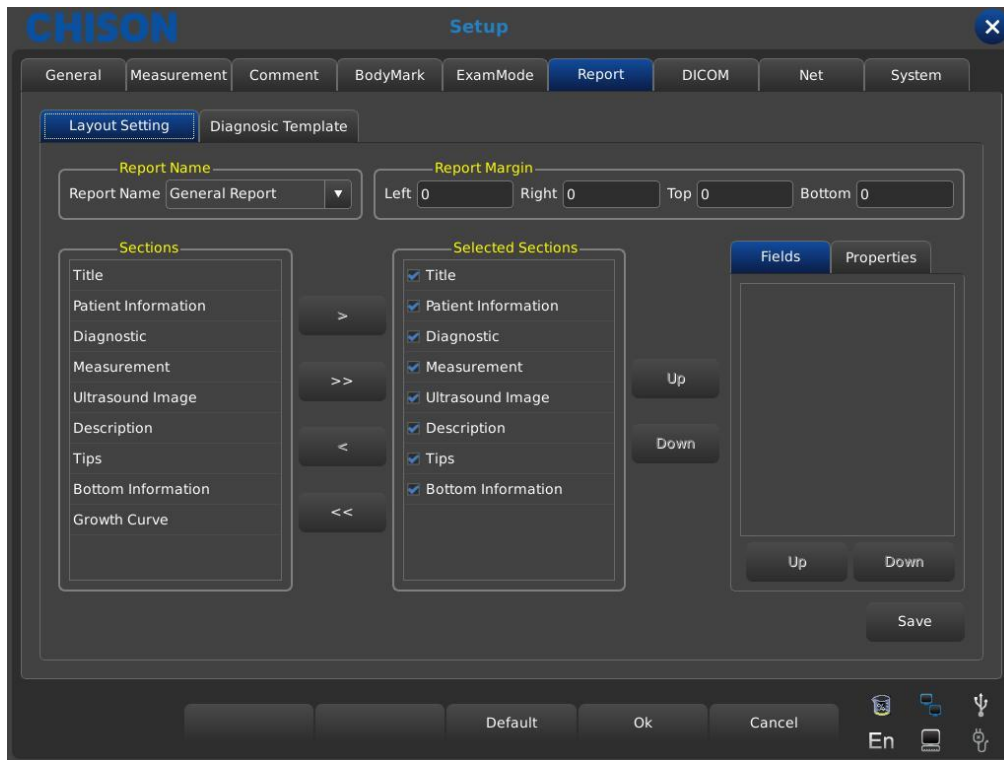

- **Report Name:** display the report type , select the report which you need to set .
- **Report Margin:** set the left, right, top and bottom space for the report margin.
- **Section:** all the optional contents you can select to display in the report.
- **Selected Sections:** show the selected contents displayed in the report.
- **>:** import the selected option from sections to the selected sections
- **>>:** import all the content from sections to the selected sections
- **<:** delete the selected content in the selected sections you does not want to display in the report.
- **<<:** delete all the content in the selected sections.
- **UP/Down (right side of the selected sections):** select **[Up]** or **[Down]** to set the displayed order of the selected contents in the report.
- **Fields:** display the corresponding content of options in the selected sections. For example, when you select title, it will display hospital name and title, you can select the content you want to display in the report or not.
- **Properties:** adjust the column or row layout in the vertical or horizontal direction for the selected content in selected sections.
- **UP/Down (on the bottom of fields):** adjust the displayed order in report for selected contents in fields.

## 7.6.2 Diagnostic Template setting

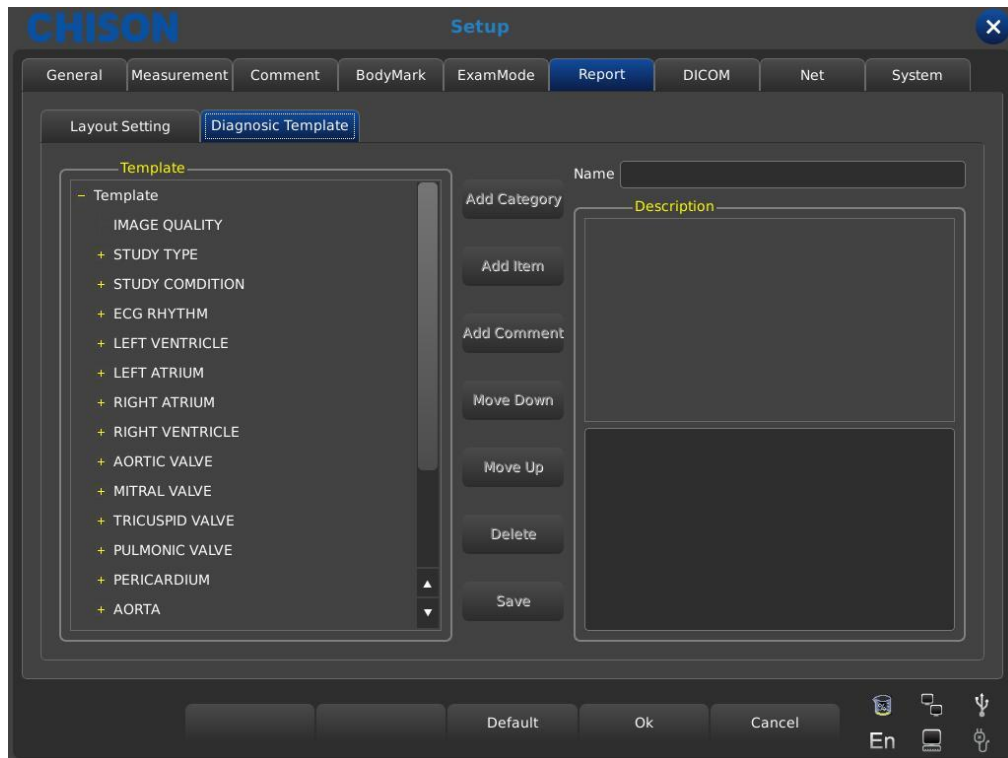

- **Template:** show the content of all the template.
- **Name:** show the name of the template you have selected.
- **Description:** the description display the detailed content of the submenu you have selected.  
when you select the option marked with "+", it will display the submenus and select an option you want to edit..
- **Add Category:** add a submenu for the option in the template you have selected. For example, when you select image quality, it will display a submenu named folder. Then you can select **[Name]** to modify the name for the folder.
- **Add Item:** add items for the submenus according to the user's requirement. After you add items, you can select **[Name]** to modify the items' name.
- **Add Comment:** add comment for the items under the submenu. After you add comment, it will display comment in the description area. Then you can select the bottom area in the description to modify the name for the comment.
- **Move Up/Move Down:** adjust the display order for the content in the template or in the description you have selected.
- **Delete:** delete the content in the template or in the description you have selected.

- **Save:** after you complete the setting, select this option to save all the modification.

## 7.7 DICOM

DICOM includes DICOM Storage, DICOM Worklist, DICOM Print and DICOM SR. If DICOM is to be applied, please make sure DICOM has been activated. In the system page of setting interface, you can check whether DICOM is open or not. If you want to activate DICOM, please contact with CHISON.

There must be DICOM SCP server which has been installed with PACS or other relative DICOM server software.

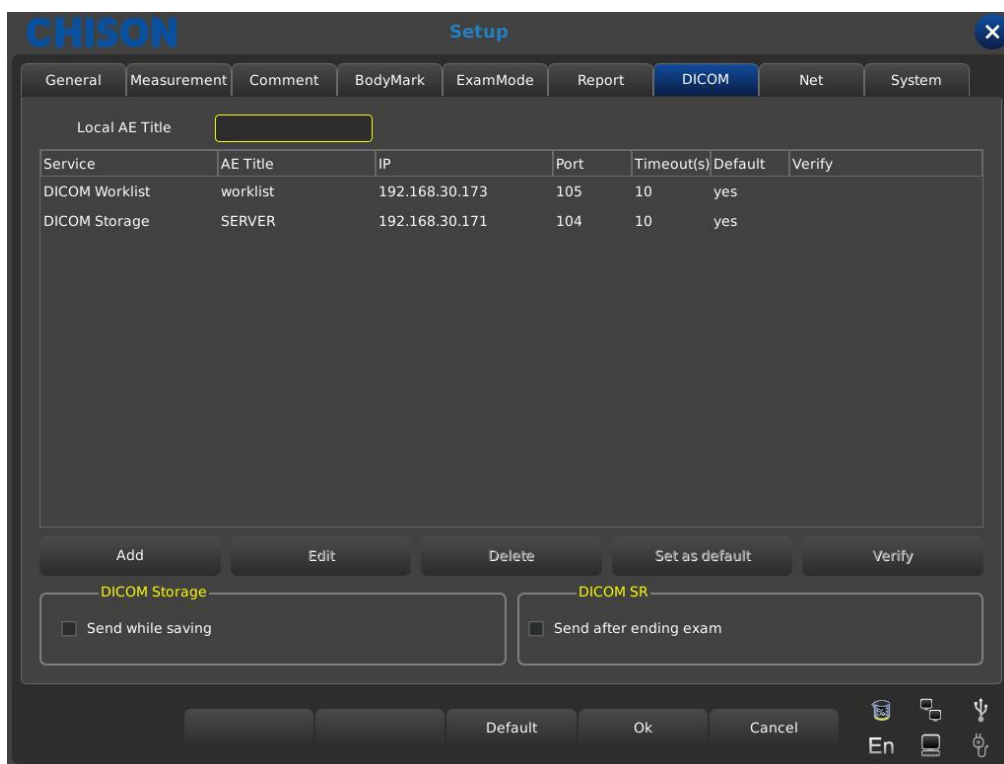

- **Local AE Title:** input local DICOM Title to separate the DICOM equipment in local network.
- **Service:** display the local DICOM function worklist.
- **AE Title:** display the name of local DICOM AE title.
- **IP:** display the IP of DICOM server.
- **Port:** display the port of DICOM server.
- **Timeout(s):** display the delay time.
- **Available:** display whether DICOM is default or not.
- **Verify:** Press verify button and display whether DICOM setting is correct or not.
- **Add:** add DICOM function and pop up setting dialog.

- **Delete:** delete the existed DICOM function.
- **Set as default:** set one DICOM service as default.
- **Verify:** affirm the DICOM function.
- **DICOM Storage:** check this item and enable DICOM storage while saving image or cine, send clip or image according to activated function.
- **DICOM SR:** select this option the system will send DICOM SR after the operator ends the exam.

### 7.7.1 Add/Edit DICOM Function

- **Default:** check this option, set DICOM function as default.
- **Service:** choose DICOM Storage, DICOM Worklist, DICOM Print or DICOM SR.
- **Server AE Title:** input DICOM server AE name.
- **Server IP address:** input DICOM IP address.
- **SCP port:** input DICOM server SCP port.
- **Timeout:** set the delay time of DICOM.

**! Tips:** choosing the DICOM Print type must be before relative print setting.

## 7.8 NET Work

Set the unit's and target unit's IP and do the connection testing. And network storage settings, details see the appendix: Procedures of setting network sharing.

## 7.9 System

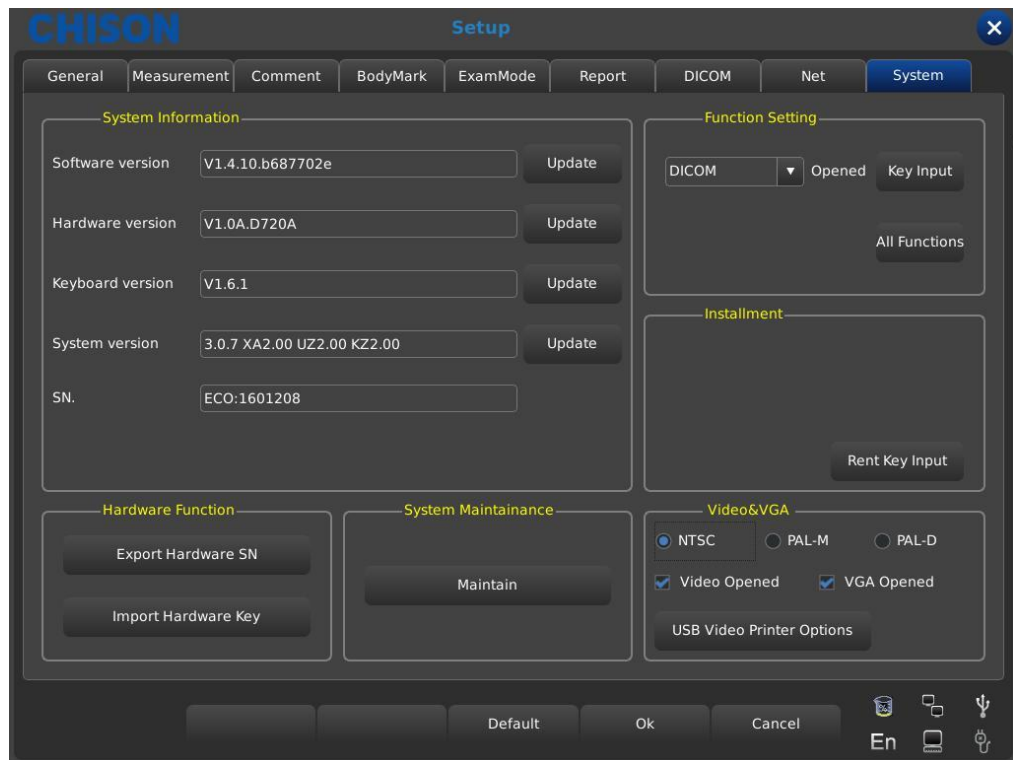

### 7.9.1 System information

Display the software version, hardware version, system version, etc.

### 7.9.2 Update

Software and Hardware can be updated by USB flash drives.

Software upgrade File Path: X:\update\XXX or X:\update\_SN\XXX. Hardware update File Path: "X:\fpga\_update\XXX", Keyboard upgrade File Path: "X:\ keyboard\_update \XXX". X means USB flash drives. XXX means upgrade content. It should restart manually after hardware update, and after software update, machine can be restarted automatically.

### 7.9.3 Function Setting

**DICOM:** Click [**Open**] key, it will bring up the DICOM Key Input dialog box. Input the DICOM SN, and click [**OK**] key to save and exit.

**Full Screen Show:** refer to DICOM.

### **7.9.4 Installment setting**

Input relevant key to open trial function and the detail please contact CHISON Company.

### **7.9.5 Video VGA**

Choose the video data: NTSC, PAL-M, and PAL-D.

Video opened: Choose the item to open this function.

VGA opened: Choose the item to open this function.

### **7.9.6 Hardware Function**

Export hardware SN and import hardware key, it only for engineer use.

### **7.9.7 System Maintenance**

Only an authorized service engineer may perform maintenance.

### **7.9.8 USB Video Printer Option**

Adjust the parameters of Video Printer Option: Dark, Light, Sharpness, and Gamma.

Select the parameters needed to adjust, press [**Confirm**] button on the slider of the parameter, and move the trackball to change the parameter.

## Chapter 8 System Maintenance

### 8.1 Machine Cleaning

**⚠ CAUTION:** do turn off the power before cleaning and pull out the cable from socket. There is possibility of electric shock if the device is on.

#### Cleaning methods:

Use the soft dry cloth to wrap the machine. If the device is quite dirty, use wet soft cloth. After wiping the blot, use soft dry cloth to wipe dry.

#### ⚠ CAUTION:

1. Don't use organic solvent such as alcohol, otherwise surface may be ruined.
2. When cleaning the machine, don't let the liquid inflow the machine, otherwise it may malfunction and there is danger of electric shock.
3. When it is necessary to clean the probe connector and peripheral instrument, please contact Sales office contact customer service or agent of CHISON. Any self-cleaning may result in malfunction or degrading the function of device.

### 8.2 Safety Check

To make sure this device works normally, a piece of maintenance plan is suggested to make to check the device regularly. If any abnormal phenomena, immediately stop operation and contact with Sale Office, Customer Service department or Agents of manufacturer.

If no image or menu but image, please check following malfunction table. If the malfunction can't be solved, please contact with Sale Office, Customer Service department or Agents of manufacturer.

### 8.3 Malfunction Check

Serial number	Malfunction	Reason	Measures
1	Switch button lights but power LED not	Battery lose efficacy, Adapter works irregular	Check the connector between cable and power
2	Power Led lights but LED no image	The interval time is too short to restart	Restart after 1 minute
3	LED display character	Launch power, gain or STC	Control launch power ,



	menu but no scan image	control errors Not connect to probe or the probe connection is not correct Device is in freezing condition	gain or STC control Make sure of right connection Exit from freezing condition
4	Abnormal image	Exam mode errors Image processing setting errors	Whether Exam mode is proper or not Adjust image processing setting or set it as default
5	Probe works improperly	1.The plug plugs loosely 2.Internal circuit protects	1.Extract the probe and reinsert 2.Restart
6	No OB calculation package menu	Do not select the OB application before scanning.	Select the OB application
7	PRINT-key doesn't work	1.The connected printer is approved 2.Printer power is not on 3.Printer is not connect well	1.Change the approved printer 2.Turn on the printer 3.Connect the printer again

## Chapter 9 Probes

### 9.1 General Description

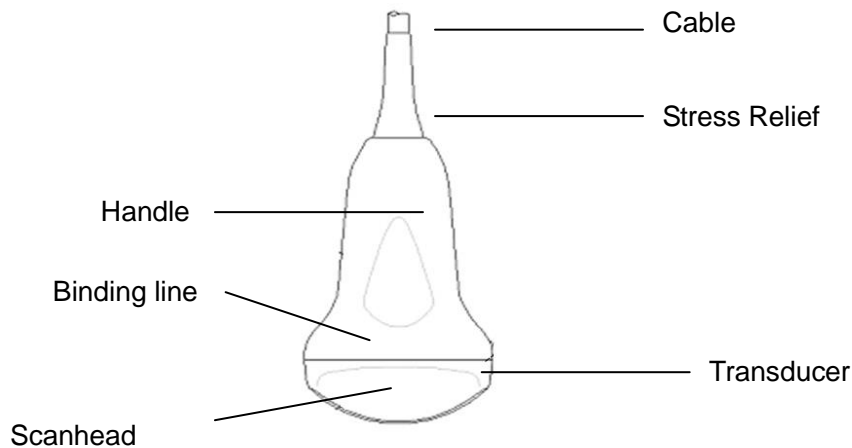

Fig. 9-1 Convex Probe Overview

The probes provide high spatial and contrast ultrasound imaging of frequencies from 2.0MHz to 11.0MHz. These probes operate by pulsing sound waves into the body and listening to the returning echoes to produce high-resolution brightness mode, and a real time display.

### 9.2 Care and Maintenance

The probes that come with the system are designed to be durable and dependable. These precision instruments should be inspected daily and handled with care. Please observe the following precautions:

1. Do not drop the transducer on hard surface. This can damage the transducer elements and compromise the electrical safety of the transducer.
2. Avoid kinking or pinching the transducer cable.
3. Use only approved ultrasonic coupling gels.
4. Follow the instructions for cleaning and disinfecting that come with each probe.

#### 9.2.1 Inspecting Probes

Before and after each use, inspect carefully the probe's lens, cable, casing, and connector. Look

for any damage that would allow liquid to enter the probe. If any damage is suspected, do not use the probe until it has been inspected and repaired/replaced by an authorized Service Representative.

 **NOTE:**

*Keep a log of all probe maintenance, along with a picture of any probe malfunction.*

 **WARNING:**

*The probes are designed to be used only with this ultrasound system. Use of these probes on any other system or a non-qualified probe may cause electrical shock or damage on the system/transducer.*

## 9.2.2 Cleaning and Disinfecting

### ◆ Cleaning

The cleaning procedure is fit for all probes. After operation every probe should do cleaning according to stated procedure of this passage. Inspection should be done for intracavity probe depends on condition of use.

#### ● **Cleaning procedure:**

1. Disconnect the probe from the ultrasound console and remove all coupling gel from the probe by wiping with a soft cloth and rinsing with flowing water.
2. Wash the probe with mild soap in lukewarm water. Scrub the probe as needed using a soft sponge, gauze, or cloth to remove all visible residue from the probe surface. Scrub the probe as needed using a soft sponge, gauze, or cloth to remove all visible residue from the probe surface.
3. Rinse the probe with enough clean, potable water to remove all disinfectant residues.
4. Use a soft cloth to clean the cable and the user section of the probe with the cleaning disinfectant liquid. Make sure that the surface of the probe and cable is wetted thoroughly with the cleaning-disinfectant.
5. Allow probe to air dry completely.
6. Reconnect the probe to the ultrasound console and place the probe into its holder.

 **WARNING:**

*To avoid electrical shock, always turn off the system and disconnect the probe before cleaning the*

probe.

** CAUTION:**

1. Take extra care when handling the lens face of the Ultrasound transducer. The lens face is especially sensitive and can easily be damaged by rough handling. NEVER use excessive force when cleaning the lens face.
2. Rinse the probe with enough clean potable water to remove all visible soap residue.
3. Air dry or dry with a soft cloth.

** CAUTION:**

To minimize the risk of infection from blood-borne pathogens, you must handle the probe and all disposables that have contacted blood, other potentially infectious materials, mucous membranes, and non-intact skin in accordance with infection control procedures. You must wear protective gloves when handling potentially infectious material. Use a face shield and gown if there is a risk of splashing or splatter.

** Disinfection**

Disinfection procedure is fit for intracavity probe.

If it is necessary to use in surgery, please abide with instruction of professional disinfection person.

** CAUTION:**

1. After each use, please disinfect the probes. Ultrasound probes can be disinfected using liquid chemical germicides. The level of disinfection is directly related to the duration of contact with the germicide. Increased contact time produces a higher level of disinfection.
2. In order for liquid chemical germicides to be effective, all visible residue must be removed during the cleaning process. Thoroughly clean the probe, as described earlier before attempting disinfection.
3. You MUST disconnect the probe from the system prior to cleaning/disinfecting the probe. Failure to do so could damage the system.
4. DO NOT soak probes in liquid chemical germicide for longer than is stated by the germicide instructions for use. Extended soaking may cause probe damage and early failure of the enclosure, resulting in possible electric shock hazard.

**● Disinfecting procedure:**

1. Obey the cleaning procedure to clean the probe totally.
2. Prepare and retreat the disinfection solution according to the instruction of manufacturer.
3. Put the insertion region of probe into disinfection solution, the inserting depth can't exceed insertion region.
4. Don't let the probe connector touch any liquid.
5. Soak the probe for 3 h.
6. Pull out the probe, immediately rinse totally with sterile water and saline. Make sure no any solution remaining. Please obey the rule to do right rinsing procedure including enough rinsing water and times.
7. When probe is used in sterile area, make sure to use disposable sterile probe hood.

** CAUTION:**

*Ultrasound transducers can easily be damaged by improper handling and by contacting with certain chemicals. Failure to follow these precautions can result in serious injury and equipment damage.*

- *Do not immerse the probe into any liquid beyond the level specified for that probe. Never immerse the transducer connector or probe adapters into any liquid.*
- *Avoid mechanical shock or impact to the transducer and do not apply excessive bending or pulling force to the cable.*
- *Transducer damage can result from contacting with inappropriate coupling or cleaning agents:*
- *Do not soak or saturate transducers with solutions containing alcohol, bleach, ammonium chloride compounds or hydrogen peroxide.*
- *Avoid contacting with solutions or coupling gels containing mineral oil or lanolin.*
- *Avoid temperatures above 60°C. Under no circumstances should the transducer be subjected to heat sterilization method. Exposure to temperatures above 60° C will cause permanent damage to the transducer.*
- *Inspect the probe prior to use for damage or degeneration to the housing, strain relief, lens and seal. Do not use a damaged or defective probe.*

**Probe Immersion Levels**

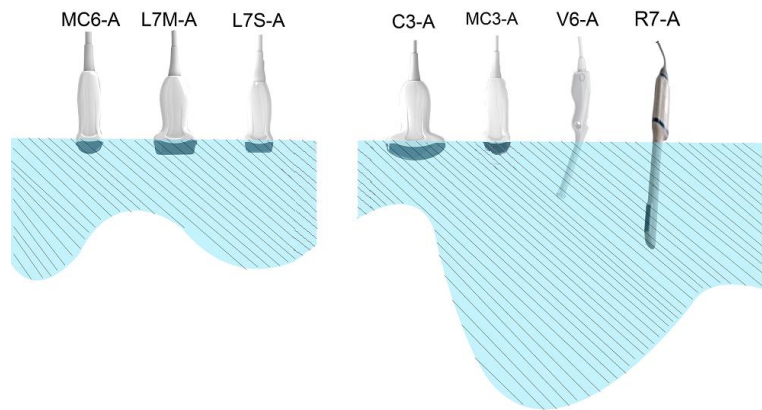

**⚠ CAUTION:**

*These transducers are not designed to withstand heat sterilization methods. Exposure to temperatures in excess of 60 °C will cause permanent damage. The transducers are not designed to be totally submerged in fluid, as permanent damage will result if the entire transducer is submerged.*

**◆ Recommended materials**

The following specific recommendations are made for the use of Endocavitary ultrasound transducers. Users should also review the Centers for Disease Control and Prevention document on sterilization and disinfection of medical devices to be certain that their procedures conform to the CDC principles for disinfection of patient care equipment.

**1. Cleaning Compatibility**

Solution	Origin	Qualified Use	Active Ingredients
CIDEZYME	All	Soaking	Enzyme
Epizyme-Rapid(Rapid Multi-Enzyme cleaner)	All	Soaking	Enzyme
ANIOSYME DD1	FRA	Soaking	Enzyme
Neodisher mediclean	DEU	Soaking	Enzyme
MetriZyme	USA	Soaking	Enzyme
Endozyme Xtreme Power	USA	Soaking	Enzyme
Sani-Cloth AF3	USA	Wiping	Quaternary ammonium chlorides

**2. Disinfecting Compatibility**

Solution	Origin	Qualified Use	Active Ingredients
Aihujia Environmental Surface Wipes	All	Wiping	Quaternary ammonium chlorides
WIP'ANIO	FRA	Wiping	Quaternary ammonium chlorides
Sani-Cloth Bleach Germicidal Wipes	USA	Wiping	Sodium hypochlorite
MetriCide OPA Plus	USA	Soaking	Orthophthalal-aldehyde
CIDEX OPA	All	Soaking	Orthophthalal-aldehyde

### **CAUTION:**

- 1. Repeated disinfection will eventually damage the transducer, please check the transducer's performance periodically.*
- 2. Other agents such as quaternary ammonium compounds are not considered high level disinfectants and should not be used. Isopropanol is not a high level disinfectant when used as a wipe and probe manufacturers generally do not recommend soaking probes in the liquid.*
- 3. The FDA has published a list of approved sterilants and high level disinfectants for use in processing reusable medical and dental devices. That list can be consulted to find agents that may be useful for probe disinfection.*
- 4. Practitioners should consult the labels of proprietary products for specific instructions. They should also consult instrument manufacturers regarding compatibility of these agents with probes. Many of the chemical disinfectants are potentially toxic and many require adequate precautions such as proper ventilation, personal protective devices (gloves, face/eye protection, etc.) and thorough rinsing before reuse of the probe.*

### **9.2.3 Deposit**

Please replace the probe in clean and dry environment, avoid direct sunshine.

Keep the environment to deposit the probe during -10~50°C, Do not put it in high pressure and vacuum environment.

When accessing probe, please be careful and avoid being ruined.

During transportation or leisure, the probe should be deposited in probe box.

## 9.2.4 Probe Safety

### 9.2.4.1 Handling Precautions

Ultrasound probes are highly sensitive medical instruments that can easily be damaged by improper handling. Use care when handling and protect from damage when not in use. DO NOT use a damaged or defective probe. Failure to follow these precautions can result in serious injury and equipment damage.

#### ◆ Electrical shock hazard

The probe is driven with electrical energy that can injure the patient or user if live internal parts are contacted by conductive solution:

- DO NOT immerse the probe into any liquid beyond the level indicated by the immersion level diagram. Never immerse the probe connector into any liquid.
- Prior to each use, visually inspect the probe lens and case area for cracks, cuts, tears, and other signs of physical damage. DO NOT use a probe that appears to be damaged until you verify functional and safe performance. You need to perform a more thorough inspection, including the cable, strain relief, and connector, each time you clean the probe.
- Before inserting the connector into the probe port, inspect the probe connector pins. If a pin is bent, DO NOT use the probe until it has been inspected and repaired/replaced by a CHISON Service Representative.
- Electrical leakage checks should be performed on a routine basis by CHISON Service or qualified hospital personnel.

#### ◆ Mechanical hazard

A defective probe or excess force can cause patient injury or probe damage:

- Observe depth markings and do not apply excessive force when inserting or manipulating endocavitary probe.
- Inspect probes for sharp edges or rough surfaces that may injure sensitive tissue.
- DO NOT apply excessive force to the probe connector when inserting into the probe port. The pin of a probe connector may bend.

#### ◆ Special handling instructions

##### Using protective sheaths



The use of market cleared probe sheaths is recommended for clinical applications. Reference FDA March 29, 1991 "Medical Alert on Latex Products".

Protective sheaths may be required to minimize disease transmission. Probe sheaths are available for use with all clinical situations where infection is a concern. Use of legally marketed, sterile probe sheaths is strongly recommended for endo-cavitary procedures.

DO NOT use pre-lubricated condoms as a sheath. In some cases, they can damage the probe. Lubricants in these condoms may not be compatible with probe construction.

Devices containing latex may cause severe allergic reaction in latex sensitive individuals. Refer to FDA's March 29, 1991 Medical Alert on latex products.

DO NOT use an expired probe sheath. Before using a sheath, verify if it has expired.

### **Endocavitary Probe Handling Precautions**

If the sterilization solution comes out of the endocavitary probe, please follow the cautions below:

**Sterilant Exposure to Patient (e.g., Cidex):** Contact with a sterilant to the patient's skin for mucous membrane may cause an inflammation. If this happens, refer to instruction manual of the sterilant.

**Sterilant Exposure from Probe handle to Patient (e.g. Cidex):** DO NOT allow the sterilant to contact the patient. Only immerse the probe to its specified level. Ensure that no solution has entered the probe's handle before scanning the patient. If sterilant comes into contact with the patient, refer to the sterilant's instruction manual.

**Sterilant Exposure from Probe connector to Patient (e.g. Cidex):** DO NOT allow the sterilant to contact the patient. Only immerse the probe to its specified level. Ensure that no solution has entered the probe's connector before scanning the patient. If sterilant comes into contact with the patient, refer to the sterilant's instruction manual.

**Endocavitary Probe Point of Contact:** Refer to the sterilant's instruction manual.

### **9.2.4.2 Probe Handling and Infection Control**

This information is intended to increase user awareness of the risks of disease transmission associated with using this equipment and provide guidance in making decisions directly affecting the safety of the patient as well as the equipment user.

Diagnostic ultrasound systems utilize ultrasound energy that must be coupled to the patient by direct physical contact.

Depending on the type of examination, this contact occurs with a variety of tissues ranging from intact skin in a routine exam to recirculating blood in a surgical procedure. The level of risk of infection varies greatly with the type of contact.

One of the most effective ways to prevent transmission between patients is with single use or disposable devices. However, ultrasound transducers are complex and expensive devices that must be reused between patients. It is very important, therefore, to minimize the risk of disease transmission by using barriers and through proper processing between patients.

#### ◆ Risk of Infection

ALWAYS clean and disinfect the probe between patients to the level appropriate for the type of examination and use FDA-cleared probe sheaths where appropriate.

Adequate cleaning and disinfection are necessary to prevent disease transmission. It is the responsibility of the equipment user to verify and maintain the effectiveness of the infection control procedures in use. Always use sterile, legally marketed probe sheaths for intra-cavitary procedures.

#### ◆ Coupling gels

DO NOT use unrecommended gels (lubricants). They may damage the probe and void the warranty. *AQUASONIC Gel made by R. P. Kincheloe Company in USA is recommended.*

In order to assure optimal transmission of energy between the patient and probe, a conductive gel must be applied liberally to the patient where scanning will be performed.

#### **CAUTION:**

*Please do not use any gel or other materials which are not provided by CHISON. Un-authorized gel, lubricants and other materials may corrode probes and other parts of the device, for example the keyboard. This may reduce the safety and effectiveness of the system and probes, and may also reduce the life time of the systems and probes. Damages caused by such reason will not be covered by the warranty.*

DO NOT apply gel to the eyes. If there is gel contact to the eye, flush eye thoroughly with water.

Coupling gels should not contain the following ingredients as they are known to cause probe damage:

- Methanol, ethanol, isopropanol, or any other alcohol-based product.
- Mineral oil
- Iodine
- Lotions
- Lanolin
- Aloe Vera
- Olive Oil
- Methyl or Ethyl Parabens (para hydroxybenzoic acid)
- Dimethyl silicone

#### **9.2.4.3 Planned and Special Maintenance**

The following maintenance plan is suggested for the system and probes to ensure optimum operation and safety.

**Daily:** inspect the probes.

**After each use:** clean the probes disinfect the probes.

**As necessary:** inspect the probes, clean the probes, and disinfect the probes.

#### **◆ Probe Covers**

The transducer should be covered with a barrier. If the barriers used are condoms, these should be nonlubricated and nonmedicated. Practitioners should be aware that condoms have been shown to be less prone to leakage than commercial probe covers, and have a six-fold enhanced AQL (acceptable quality level) when compared to standard examination gloves. They have an AQL equal to that of surgical gloves. Users should be aware of latex-sensitivity issues and have available nonlatex-containing barriers.

#### **◆ Returning/Shipping Probes and Repair Parts**

Transportation dept. and our policy require that equipment returned for service **MUST** be clean and free of blood and other infectious substances.

When you return a probe or part for service, you need to clean and disinfect the probe or part prior

to packing and shipping the equipment.

Ensure that you follow probe cleaning and disinfection instructions provided in this Manual.

This ensures that employees in the transportation industry as well as the people who receive the package are protected from any risk.

#### **9.2.4.4 AIUM Outlines Cleaning the Endocavitary Transducer**

Guidelines for Cleaning and Preparing Endocavitary Ultrasound Transducers between Patients from AIUM

*Approved June 4, 2003*

The purpose of this document is to provide guidance regarding the cleaning and disinfection of transvaginal and transrectal ultrasound probes.

All sterilization/disinfection represents a statistical reduction in the number of microbes present on a surface. Meticulous cleaning of the instrument is the essential icon to an initial reduction of the microbial/organic load by at least 99%. This cleaning is followed by a disinfecting procedure to ensure a high degree of protection from infectious disease transmission, even if a disposable barrier covers the instrument during use.

Medical instruments fall into different categories with respect to potential for infection transmission. The most critical level of instruments are those that are intended to penetrate skin or mucous membranes. These require sterilization. Less critical instruments (often called "semi-critical" instruments) that simply come into contact with mucous membranes such as fiber optic endoscopes require high-level disinfection rather than sterilization.

Although endocavitary ultrasound probes might be considered even less critical instruments because they are routinely protected by single use disposable probe covers, leakage rates of 0.9% - 2% for condoms and 8%-81% for commercial probe covers have been observed in recent studies. For maximum safety, one should therefore perform high-level disinfection of the probe between each use and use a probe cover or condom as an aid in keeping the probe clean.

There are four generally recognized categories of disinfection and sterilization. Sterilization is the

complete elimination of all forms of microbial life including spores and viruses.

**Disinfection**, the selective removal of microbial life, is divided into three classes:

**High-Level Disinfection** - Destruction/removal of all microorganisms except bacterial spores.

**Mid-Level Disinfection** - Inactivation of Mycobacterium Tuberculosis, bacteria, most viruses, fungi, and some bacterial spores.

**Low-Level Disinfection** - Destruction of most bacteria, some viruses and some fungi. Low-level disinfection will not necessarily inactivate Mycobacterium Tuberculosis or bacterial spores.

#### 9.2.4.5 Aseptic Technique

For the protection of the patient and the health care worker, all endocavitary examinations should be performed with the operator properly gloved throughout the procedure. Gloves should be used to remove the condom or other barrier from the transducer and to wash the transducer as outlined above. As the barrier (condom) is removed, care should be taken not to contaminate the probe with secretions from the patient. At the completion of the procedure, hands should be thoroughly washed with soap and water.

 **NOTE:** *Obvious disruption in condom integrity does NOT require modification of this protocol. These guidelines take into account possible probe contamination due to a disruption in the barrier sheath.*

In summary, routine high-level disinfection of the endocavitary probe between patients, plus the use of a probe cover or condom during each examination is required to properly protect patients from infection during endocavitary examinations. For all chemical disinfectants, precautions must be taken to protect workers and patients from the toxicity of the disinfectant.

Amis S, Ruddy M, Kibbler CC, Economides DL, MacLean AB. Assessment of condoms as probe covers for transvaginal sonography. *J Clin Ultrasound* 2000;28:295-8.

Rooks VJ, Yancey MK, Elg SA, Brueske L. Comparison of probe sheaths for endovaginal sonography. *Obstet. Gynecol* 1996;87:27-9.

Milki AA, Fisch JD. Vaginal ultrasound probe cover leakage: implications for patient care. *Fertil*

Steril

1998;69:409-11.

Hignett M, Claman P. High rates of perforation are found in endovaginal ultrasound probe covers before and after oocyte retrieval for in vitro fertilization-embryo transfer. J Assist Reprod Genet 1995;12:606-9.

Sterilization and Disinfection of Medical Devices: General Principles. Centers for Disease Control, Division of Healthcare Quality Promotion. <http://www.cdc.gov/ncidod/hip/sterile/sterilgp.htm> (5-2003).

ODE Device Evaluation Information--FDA Cleared Sterilants and High Level Disinfectants with General Claims for Processing Reusable Medical and Dental Devices, March 2003. <http://www.fda.gov/cdrh/ode/germlab.html> (5-2003).

## **9.3 Probe Operation Instructions**

Instructions for connecting, activating, deactivating, disconnecting, transporting and storing the probes.

### **9.3.1 Scanning the Patient**

In order to assure optimal transmission of energy between the patient and probe, a conductive gel must be applied liberally to the patient where scanning will be performed.

After the examination is complete, follow the cleaning and disinfecting, or sterilizing procedures as appropriate.

### **9.3.2 Operating Transvaginal Probe**

The transvaginal probe is an endo-cavity probe, for the operation safety, please refer to “Care and Maintenance” for cleaning and disinfection.

The temperature at the tip of the probe displays on the screen for monitoring. No temperature above 43° C is allowed. It also depends on the patient's body temperature. When the temperature

of probe tip exceeds 43° C, the probe will stop working immediately to protect the patient.

Transvaginal probe should be used with FDA approved condom or probe cover. See the following instructions to put the probe into the condom:

### **CAUTION:**

- *Some patients may be allergic to natural rubber or medical device with rubber contains. FDA suggests that the user identify these patients and be prepared to treat allergic reactions promptly before scanning.*
- *Only water-solvable solutions or gel can be used. Petroleum or mineral oil-based materials may harm the cover.*
- *When the transvaginal probe is activated outside patient's body, its acoustic output level should be decreased to avoid any harmful interference with other equipment.*

### **Operation Procedure:**

- Put on medical sterile glove
- Get the condom for the package.
- Unfold the condom.
- Load some ultrasound gel into condom.
- Take the condom with one hand, and put the probe head into the condom.
- Fasten the condom on the end of the probe handle.
- Confirm the integrity of the condom, and repeat the above steps to the condom if any damage to the condom is found.

## **9.3.3 Cleaning and Disinfecting TV and TR Probes**

**We strongly recommend wearing gloves when cleaning and disinfecting any endocavitary probe.**

- Every time before and after each exam, please clean the probe handle and disinfect the transvaginal and transrectal probes probe using liquid chemical germicides
- If the probe is contaminated with body fluids, you should disinfect the probe after cleaning.
- Regard any exam waste as potentially infectious and dispose of it accordingly.

### **CAUTION:**

*Since the probe is not waterproof, you should disconnect it from the system before cleaning or disinfecting.*

*Before and after each exam, please clean the probe handle and disinfect the transvaginal and transrectal probes using liquid chemical germicides.*

## **Cleaning**

You can clean the transvaginal and transrectal probes to remove all coupling gel by wiping with a soft cloth and rinsing with flowing water. Then wash the probe with mild soap in lukewarm water. Scrub the probe as needed and use a soft cloth to remove all visible residues from the transvaginal probe surface. Rinse the probe with enough clean potable water to remove all visible soap residues, and let the probe air dry.

### **CAUTION:**

*Please remove the cover (if any) before cleaning the probe. (The cover like condom is one time usable).*

*When cleaning the TV and TR probes, it is important to be sure that all surfaces are thoroughly cleaned.*

## **Disinfecting**

Cidex is the only germicide that has been evaluated for compatibility with the material used to construct the probes.

To keep the effectiveness of the disinfection solutions, a thoroughly cleaning must be done to the probe before the disinfecting, make sure no residues remain on the probe.

### **Disinfecting Procedure:**

1. Following all precautions for storage, use and disposal, prepare the germicide solution according to the manufacturer's instructions.
2. Place the cleaned and dried probe to contact with the germicide, being careful not to let the probe drop to the bottom of the container and thus damage the probe.
3. After placing/immersing, rotate and shake the probe while it is below the surface of the



germicide to eliminate air pockets. Allow the germicide to remain in contact with the fully immersed probe. For high level disinfection, follow the manufacturer's recommended time.

4. Following all precautions for storage, use and disposal, prepare the germicide solution according to the manufacturer's instructions.

5. After removing from the germicide, rinse the probe according to the germicide manufacturer's rinsing instructions.

6. Flush all visible germicide residues from the probe and allow to air dry.

## **9.4 Service Responsibility**

If users install, use and maintain the system fully according to CHISON's installation manual, operation manual and service manual, then CHISON ECO main unit has a life time of 5 years and CHISON ECO probes have life time of 5 years after ex-work.

The warranty of the system and probes after ex-work is as the time in the warranty card.

The system is a precise electronic system. Only the CHISON's authorized service engineer could replace the defective parts. Any assembly, disassembly, handling, repair, or replacement by any other people may have adverse impact on the safety and effectiveness of the systems and probes, and thus will reduce the life time of the system and probes, and such systems and probes will not be covered by CHISON warranty after the above improper handling. Standard maintenance must be performed by CHISON's authorized service engineer during the life time of the product.



**CAUTION:** *When the above life time is expired, the effectiveness and safety of system and probes maybe greatly affected, so it's NOT suggested to continue using the system and probes even the system and probes seem work properly. But if user still wants to continue using the system and probes, user should first contact CHISON service center at CHISON headquarter to arrange the necessary safety check and calibration by CHISON's authorized service engineer. If CHISON headquarter service center provides the calibration certificate for the related system or probe, then user could continue use the system or probes according to the calibration certificate. However, if CHISON headquarter service center concludes that the system or probe is no longer complied to the safety and effectiveness standard, then user should immediately stop using the system or probe. User understands that such check and calibration cost will be born by the user.*

*Systems and probes keep on using after the life time may also be difficult to repair and maintain, so it's suggested to renew the product after the life time.*

## **Appendix A: The Information of EC Representative**

Shanghai International Holding Corp.GmbH (Europe)

Add: Eiffestrasse 80,20537 Hamburg,Germany

Tel: 0049-40-2513175

Fax: 0049-40-255726

E-mail: antonsissi@hotmail.com shholding@hotmail.com

## Appendix B: Acoustic Output Report Table

Transducer Model: C3-A

Operating Mode: B

Index label			MI	TIS		TIB		TIC
				At surface	Below surface	At surface	Below surface	
Maximum index value			0.50	0.10		0.10		–
Index component value				0.10	0.10	0.08	0.10	
Acoustic Parameters	$p_{r,\alpha}$ at $Z_{MI}$	Mpa	0.92					
	P	mW		2.00		2.00		–
	$P_{1 \times 1}$	mW		0.29		0.29		
	$Z_s$	cm			–			
	$Z_b$	cm					–	
	$Z_{MI}$	cm	3.11					
	$Z_{pii,\alpha}$	cm	–					
	$f_{awf}$	MHz	3.65	3.75		3.75		–
Other Information	pr	Hz	–					
	srr	Hz	17.92					
	$n_{pps}$		1					
	$I_{pa,\alpha}$ at $Z_{pii,\alpha}$	W/cm <sup>2</sup>	–					
	$I_{spta,\alpha}$ at $Z_{pii,\alpha}$ or $Z_{sii,\alpha}$	mW/cm <sup>2</sup>	36.15					
	$I_{spta}$ at $Z_{pii}$ or $Z_{sii}$	mW/cm <sup>2</sup>	55.21					
	$p_r$ at $Z_{pii}$	Mpa	–					
Operating Control Conditions	Focus	cm	6.00	4.00		4.00		–
	Power	%	100	100		100		–

NOTE 1 Only one operating condition per index.

NOTE 2 Data should be entered for “at surface” and “below surface” both in the columns related to TIS or TIB.

NOTE 3 Information need not be provided regarding TIC for any TRANSDUCER ASSEMBLY not intended for transcranial or neonatal cephalic uses.

NOTE 4 If the requirements of 201.12.4.2a) are met, it is not required to enter any data in the columns related to TIS, TIB or TIC.

NOTE 5 If the requirements of 201.12.4.2b) are met, it is not required to enter any data in the column related to MI.

NOTE 6 The depths  $Z_{pii}$  and  $Z_{pii,\alpha}$  apply to NON-SCANNING MODES, while the depths  $Z_{sii}$  and  $Z_{sii,\alpha}$  apply to SCANNING MODES.

**Transducer Model: C3-A**

**Operating Mode: THI-B**

Index label			MI	TIS		TIB		TIC
				At surface	Below surface	At surface	Below surface	
Maximum index value			0.50	0.10		0.10		–
Index component value				0.10	0.10	0.09	0.10	
Acoustic Parameters	$p_{r,\alpha}$ at $Z_{MI}$	Mpa	0.94					
	P	mW		2.01		2.01		–
	$P_{1 \times 1}$	mW		0.29		0.29		
	$Z_s$	cm			–			
	$Z_b$	cm					–	
	$Z_{MI}$	cm	3.11					
	$Z_{pii,\alpha}$	cm	–					
	$f_{awf}$	MHz	3.55	3.68		3.68		–
Other Information	pr	Hz	–					
	sr	Hz	18.60					
	$n_{pps}$		1					
	$I_{pa,\alpha}$ at $Z_{pii,\alpha}$	W/cm <sup>2</sup>	–					
	$I_{spta,\alpha}$ at $Z_{pii,\alpha}$ or $Z_{sii,\alpha}$	mW/cm <sup>2</sup>	35.20					
	$I_{spta}$ at $Z_{pii}$ or $Z_{sii}$	mW/cm <sup>2</sup>	58.62					
	$p_r$ at $Z_{pii}$	Mpa	–					
Operating Control Conditions	Focus	cm	6.00	2.00		2.00		–
	Power	%	100	100		100		–

NOTE 1 Only one operating condition per index.

NOTE 2 Data should be entered for “at surface” and “below surface” both in the columns related to TIS or TIB.

NOTE 3 Information need not be provided regarding TIC for any TRANSDUCER ASSEMBLY not intended for transcranial or neonatal cephalic uses.

NOTE 4 If the requirements of 201.12.4.2a) are met, it is not required to enter any data in the columns related to TIS, TIB or TIC.

NOTE 5 If the requirements of 201.12.4.2b) are met, it is not required to enter any data in the column related to MI.

NOTE 6 The depths  $Z_{pii}$  and  $Z_{pii,\alpha}$  apply to NON-SCANNING MODES, while the depths  $Z_{sii}$  and  $Z_{sii,\alpha}$  apply to SCANNING MODES.

Transducer Model: **C3-A**Operating Mode: **B+M**

Index label			MI	TIS		TIB		TIC
				At surface	Below surface	At surface	Below surface	
Maximum index value			0.40	0.20		0.30		–
Index component value				0.14	0.20	0.25	0.30	
Acoustic Parameters	$p_{r,\alpha}$ at $Z_{MI}$	<i>Mpa</i>	0.66					
	P	mW		24.00		24.00		–
	$P_{1 \times 1}$	mW		3.45		3.45		
	$Z_s$	cm			3.06			
	$Z_b$	cm					3.54	
	$Z_{MI}$	cm	2.88					
	$Z_{pii,\alpha}$	cm	2.91					
	$f_{awf}$	MHz	3.56	3.55		3.59		–
Other Information	pr	Hz	2293.60					
	sr	Hz	17.92					
	$n_{pps}$		1					
	$I_{pa,\alpha}$ at $Z_{pii,\alpha}$	$W/cm^2$	22.80					
	$I_{spta,\alpha}$ at $Z_{pii,\alpha}$ or $Z_{sii,\alpha}$	$mW/cm^2$	25.61					
	$I_{spta}$ at $Z_{pii}$ or $Z_{sii}$	$mW/cm^2$	56.14					
$p_r$ at $Z_{pii}$	<i>Mpa</i>	0.95						
Operating Control Conditions	Focus	cm	5.00	11.00		6.00		–
	Power	%	100	100		100		–

NOTE 1 Only one operating condition per index.

NOTE 2 Data should be entered for “at surface” and “below surface” both in the columns related to TIS or TIB.

NOTE 3 Information need not be provided regarding TIC for any TRANSDUCER ASSEMBLY not intended for transcranial or neonatal cephalic uses.

NOTE 4 If the requirements of 201.12.4.2a) are met, it is not required to enter any data in the columns related to TIS, TIB or TIC.

NOTE 5 If the requirements of 201.12.4.2b) are met, it is not required to enter any

data in the column related to MI.

NOTE 6 The depths  $z_{pii}$  and  $z_{pii,\alpha}$  apply to NON-SCANNING MODES, while the depths  $z_{sii}$  and  $z_{sii,\alpha}$  apply to SCANNING MODES.

**Transducer Model:** C3-A

**Operating Mode:** THI-B+M

Index label			MI	TIS		TIB		TIC
				At surface	Below surface	At surface	Below surface	
Maximum index value			0.40	0.20		0.30		–
Index component value				0.14	0.20	0.22	0.30	
Acoustic Parameters	$p_{r,\alpha}$ at $Z_{MI}$	Mpa	0.66					
	P	mW		23.55		23.55		–
	$P_{1x1}$	mW		3.38		3.38		
	$Z_s$	cm			3.05			
	$Z_b$	cm					3.54	
	$Z_{MI}$	cm	2.85					
	$z_{pii,\alpha}$	cm	2.91					
	$f_{awf}$	MHz	3.48	3.50		3.45		–
Other Information	$p_{rr}$	Hz	2293.60					
	$s_{rr}$	Hz	17.92					
	$n_{pps}$		1					
	$I_{pa,\alpha}$ at $z_{pii,\alpha}$	W/cm <sup>2</sup>	15.02					
	$I_{spta,\alpha}$ at $z_{pii,\alpha}$ or $z_{sii,\alpha}$	mW/cm <sup>2</sup>	17.33					
	$I_{spta}$ at $z_{pii}$ or $z_{sii}$	mW/cm <sup>2</sup>	33.56					
$p_r$ at $z_{pii}$	Mpa	0.87						
Operating Control Conditions	Focus	cm	5.00	11.00		6.00		–
	Power	%	100	100		100		–

NOTE 1 Only one operating condition per index.

NOTE 2 Data should be entered for “at surface” and “below surface” both in the columns related to TIS or TIB.

NOTE 3 Information need not be provided regarding TIC for any TRANSDUCER ASSEMBLY not intended for transcranial or neonatal cephalic uses.

NOTE 4 If the requirements of 201.12.4.2a) are met, it is not required to enter any data in the columns related to TIS, TIB or TIC.

NOTE 5 If the requirements of 201.12.4.2b) are met, it is not required to enter any data in the column related to MI.

NOTE 6 The depths  $z_{pii}$  and  $z_{pii,\alpha}$  apply to NON-SCANNING MODES, while the depths  $z_{sii}$  and  $z_{sii,\alpha}$  apply to SCANNING MODES.

**Transducer Model:** C3-A

**Operating Mode:** B+C

Index label			MI	TIS		TIB		TIC
				At surface	Below surface	At surface	Below surface	
Maximum index value			0.30	0.10		0.10		–
Index component value				0.10	0.10	0.09	0.10	
Acoustic Parameter s	$p_{r,\alpha}$ at $Z_{MI}$	Mpa	0.64					
	P	mW		20.00		20.00		–
	$P_{1x1}$	mW		2.87		2.87		
	$Z_s$	cm			–			
	$Z_b$	cm					–	
	$Z_{MI}$	cm	3.51					
	$z_{pii,\alpha}$	cm	–					
	$f_{awf}$	MHz	3.85	4.00		4.00		–
Other Information	pr	Hz	–					
	sr	Hz	14.26					
	$n_{pps}$		1					
	$I_{pa,\alpha}$ at $z_{pii,\alpha}$	W/cm <sup>2</sup>	–					
	$I_{spta,\alpha}$ at $z_{pii,\alpha}$ or $z_{sii,\alpha}$	mW/cm <sup>2</sup>	43.21					
	$I_{spta}$ at $z_{pii}$ or $z_{sii}$	mW/cm <sup>2</sup>	65.25					
	$p_r$ at $z_{pii}$	Mpa	–					
Operating Control Conditions	Focus	cm	5.00	3.00		3.00		–
	Power	%	100	100		100		–

NOTE 1 Only one operating condition per index.

NOTE 2 Data should be entered for “at surface” and “below surface” both in the columns related to TIS or TIB.

NOTE 3 Information need not be provided regarding TIC for any TRANSDUCER ASSEMBLY not intended for transcranial or neonatal cephalic uses.



NOTE 4 If the requirements of 201.12.4.2a) are met, it is not required to enter any data in the columns related to TIS, TIB or TIC.

NOTE 5 If the requirements of 201.12.4.2b) are met, it is not required to enter any data in the column related to MI.

NOTE 6 The depths  $z_{pii}$  and  $z_{pii,\alpha}$  apply to NON-SCANNING MODES, while the depths  $z_{sii}$  and  $z_{sii,\alpha}$  apply to SCANNING MODES.

**Transducer Model: C3-A**

**Operating Mode: PW**

Index label			MI	TIS		TIB		TIC
				At surface	Below surface	At surface	Below surface	
Maximum index value			0.60	0.40		0.70		–
Index component value				0.35	0.40	0.66	0.70	
Acoustic Parameter s	$p_{r,\alpha}$ at $Z_{MI}$	Mpa	1.00					
	P	mW		36.00		36.00		–
	$P_{1 \times 1}$	mW		5.17		5.17		
	$Z_s$	cm			2.50			
	$Z_b$	cm					4.95	
	$Z_{MI}$	cm	4.46					
	$Z_{pii,\alpha}$	cm	5.00					
	$f_{awf}$	MHz	2.89		3.90		2.89	
Other Informatio n	prr	Hz	4386.00					
	srr	Hz	–					
	$n_{pps}$		1					
	$I_{pa,\alpha}$ at $Z_{pii,\alpha}$	W/cm <sup>2</sup>	36.31					
	$I_{spta,\alpha}$ at $Z_{pii,\alpha}$ or $Z_{sii,\alpha}$	mW/cm <sup>2</sup>	35.20					
	$I_{spta}$ at $Z_{pii}$ or $Z_{sii}$	mW/cm <sup>2</sup>	58.54					
	$p_r$ at $Z_{pii}$	Mpa	1.60					
Operating Control Conditons	Focus	cm	9.00	6.00		13.00		–
	Power	%	100	100		100		–

NOTE 1 Only one operating condition per index.

NOTE 2 Data should be entered for “at surface” and “below surface” both in the columns related to TIS or TIB.

NOTE 3 Information need not be provided regarding TIC for any TRANSDUCER ASSEMBLY not intended for transcranial or neonatal cephalic uses.

NOTE 4 If the requirements of 201.12.4.2a) are met, it is not required to enter any data in the columns related to TIS, TIB or TIC.

NOTE 5 If the requirements of 201.12.4.2b) are met, it is not required to enter any data in the column related to MI.

NOTE 6 The depths  $z_{pii}$  and  $z_{pii,\alpha}$  apply to NON-SCANNING MODES, while the depths  $z_{sii}$  and  $z_{sii,\alpha}$  apply to SCANNING MODES.

Transducer Model: V6-A

Operating Mode: B

Index label			MI	TIS		TIB		TIC
				At surface	Below surface	At surface	Below surface	
Maximum index value			0.40	0.10		0.10		–
Index component value				0.10	0.10	0.09	0.10	
Acoustic Parameters	$p_{r,\alpha}$ at $Z_{MI}$	Mpa	0.91					
	P	mW		2.00		2.00		–
	$P_{1x1}$	mW		0.69		0.69		
	$Z_s$	cm			–			
	$Z_b$	cm					–	
	$Z_{MI}$	cm	3.25					
	$z_{pii,\alpha}$	cm	–					
	$f_{awf}$	MHz	5.68		5.71		5.71	
Other Information	prr	Hz	–					
	srr	Hz	30.05					
	$n_{pps}$		1					
	$I_{pa,\alpha}$ at $z_{pii,\alpha}$	W/cm <sup>2</sup>	–					
	$I_{spta,\alpha}$ at $z_{pii,\alpha}$ or $z_{sii,\alpha}$	mW/cm <sup>2</sup>	25.44					
	$I_{spta}$ at $z_{pii}$ or $z_{sii}$	mW/cm <sup>2</sup>	44.55					
	$p_r$ at $z_{pii}$	Mpa	–					
Operating Control Conditions	Focus	cm	1.00	0.50		0.50		–
	Power	%	100	100		100		–

NOTE 1 Only one operating condition per index.

NOTE 2 Data should be entered for “at surface” and “below surface” both in the columns related to TIS or TIB.

NOTE 3 Information need not be provided regarding TIC for any TRANSDUCER ASSEMBLY not intended for transcranial or neonatal cephalic uses.

NOTE 4 If the requirements of 201.12.4.2a) are met, it is not required to enter any data in the columns related to TIS, TIB or TIC.

NOTE 5 If the requirements of 201.12.4.2b) are met, it is not required to enter any data in the column related to MI.

NOTE 6 The depths  $z_{pii}$  and  $z_{pii,\alpha}$  apply to NON-SCANNING MODES, while the depths  $z_{sii}$  and  $z_{sii,\alpha}$  apply to SCANNING MODES.

Transducer Model: V6-A

Operating Mode: THI-B

Index label			MI	TIS		TIB		TIC
				At surface	Below surface	At surface	Below surface	
Maximum index value			0.60	0.30		0.30		–
Index component value				0.30	0.30	0.22	0.30	
Acoustic Parameters	$p_{r,\alpha}$ at $Z_{MI}$	Mpa	1.44					
	P	mW		18.00		18.00		–
	$P_{1 \times 1}$	mW		6.25		6.25		
	$Z_s$	cm			–			
	$Z_b$	cm					–	
	$Z_{MI}$	cm	3.33					
	$z_{pii,\alpha}$	cm	–					
	$f_{awf}$	MHz	5.74	5.74		5.74		–
Other Information	prr	Hz	–					
	srr	Hz	37.92					
	$n_{pps}$		1					
	$I_{pa,\alpha}$ at $z_{pii,\alpha}$	W/cm <sup>2</sup>	–					
	$I_{spta,\alpha}$ at $z_{pii,\alpha}$ or $z_{sii,\alpha}$	mW/cm <sup>2</sup>	88.64					
	$I_{spta}$ at $z_{pii}$ or $z_{sii}$	mW/cm <sup>2</sup>	105.23					
$p_r$ at $z_{pii}$	Mpa	–						
Operating Control Conditions	Focus	cm	3.50	3.00		3.00		–
	Power	%	100	100		100		–

NOTE 1 Only one operating condition per index.

NOTE 2 Data should be entered for “at surface” and “below surface” both in the columns related to TIS or TIB.

NOTE 3 Information need not be provided regarding TIC for any TRANSDUCER ASSEMBLY not intended for transcranial or neonatal cephalic uses.

NOTE 4 If the requirements of 201.12.4.2a) are met, it is not required to enter any data in the columns related to TIS, TIB or TIC.

NOTE 5 If the requirements of 201.12.4.2b) are met, it is not required to enter any data in the column related to MI.

NOTE 6 The depths  $z_{pii}$  and  $z_{pii,\alpha}$  apply to NON-SCANNING MODES, while the depths  $z_{sii}$  and  $z_{sii,\alpha}$  apply to SCANNING MODES.

**Transducer Model: V6-A**

**Operating Mode: B+M**

Index label			MI	TIS		TIB		TIC
				At surface	Below surface	At surface	Below surface	
Maximum index value			0.80	0.10		0.10		–
Index component value				0.08	0.10	0.07	0.10	
Acoustic Parameter s	$p_{r,\alpha}$ at $Z_{MI}$	Mpa	1.89					
	P	mW		2.00		2.00		–
	$P_{1 \times 1}$	mW		0.69		0.69		
	$Z_s$	cm			3.88			
	$Z_b$	cm					3.97	
	$Z_{MI}$	cm	3.84					
	$z_{pii,\alpha}$	cm	3.97					
	$f_{awf}$	MHz	5.03	5.54		5.03		–
Other Informatio n	pr	Hz	3846.2 0					
	srr	Hz	30.05					
	$n_{pps}$		1					
	$I_{pa,\alpha}$ at $z_{pii,\alpha}$	W/cm <sup>2</sup>	154.43					
	$I_{spta,\alpha}$ at $z_{pii,\alpha}$ or $z_{sii,\alpha}$	mW/cm <sup>2</sup>	153.23					
	$I_{spta}$ at $z_{pii}$ or $z_{sii}$	mW/cm <sup>2</sup>	175.22					
$p_r$ at $z_{pii}$	Mpa	3.73						
Operating Control Conditons	Focus	cm	1.50	0.50		1.50		–
	Power	%	100	100		100		–

NOTE 1 Only one operating condition per index.

NOTE 2 Data should be entered for “at surface” and “below surface” both in the columns related to TIS or TIB.

NOTE 3 Information need not be provided regarding TIC for any TRANSDUCER ASSEMBLY not intended for transcranial or neonatal cephalic uses.

NOTE 4 If the requirements of 201.12.4.2a) are met, it is not required to enter any data in the columns related to TIS, TIB or TIC.

NOTE 5 If the requirements of 201.12.4.2b) are met, it is not required to enter any data in the column related to MI.

NOTE 6 The depths  $z_{pii}$  and  $z_{pii,\alpha}$  apply to NON-SCANNING MODES, while the depths  $z_{sii}$  and  $z_{sii,\alpha}$  apply to SCANNING MODES.

**Transducer Model:** V6-A

**Operating Mode:** THI-B+M

Index label			MI	TIS		TIB		TIC
				At surface	Below surface	At surface	Below surface	
Maximum index value			0.70	0.10		0.10		—
Index component value				0.06	0.10	0.09	0.10	
Acoustic Parameter s	$p_{r,\alpha}$ at $Z_{MI}$	Mpa	1.89					
	P	mW		2.00		2.00		—
	$P_{1 \times 1}$	mW		0.69		0.69		
	$Z_s$	cm			3.89			
	$Z_b$	cm					3.97	
	$Z_{MI}$	cm	3.88					
	$z_{pii,\alpha}$	cm	3.95					
	$f_{awf}$	MHz	5.05	5.48		5.05		—
Other Informatio n	pr	Hz	3846.2 0					
	srr	Hz	30.05					
	$n_{pps}$		1					
	$I_{pa,\alpha}$ at $z_{pii,\alpha}$	W/cm <sup>2</sup>	154.36					
	$I_{spta,\alpha}$ at $z_{pii,\alpha}$ or $z_{sii,\alpha}$	mW/cm <sup>2</sup>	155.26					
	$I_{spta}$ at $z_{pii}$ or $z_{sii}$	mW/cm <sup>2</sup>	173.26					
$p_r$ at $z_{pii}$	Mpa	3.73						
Operating Control Conditons	Focus	cm	1.50	0.50		1.50		—
	Power	%	100	100		100		—

NOTE 1 Only one operating condition per index.

NOTE 2 Data should be entered for “at surface” and “below surface” both in the columns related to TIS or TIB.

NOTE 3 Information need not be provided regarding TIC for any TRANSDUCER ASSEMBLY not intended for transcranial or neonatal cephalic uses.

NOTE 4 If the requirements of 201.12.4.2a) are met, it is not required to enter any data in the columns related to TIS, TIB or TIC.

NOTE 5 If the requirements of 201.12.4.2b) are met, it is not required to enter any data in the column related to MI.

NOTE 6 The depths  $z_{pii}$  and  $z_{pii,\alpha}$  apply to NON-SCANNING MODES, while the depths  $z_{sii}$  and  $z_{sii,\alpha}$  apply to SCANNING MODES.

**Transducer Model: V6-A**

**Operating Mode: B+C**

Index label			MI	TIS		TIB		TIC
				At surface	Below surface	At surface	Below surface	
Maximum index value			0.40	0.10		0.10		–
Index component value				0.10	0.10	0.08	0.10	
Acoustic Parameters	$p_{r,\alpha}$ at $Z_{MI}$	Mpa	1.00					
	P	mW		2.00		2.00		–
	$P_{1 \times 1}$	mW		0.69		0.69		
	$Z_s$	cm			–			
	$Z_b$	cm					–	
	$Z_{MI}$	cm	1.99					
	$z_{pii,\alpha}$	cm	–					
	$f_{awf}$	MHz	6.27	6.27		6.27		–
Other Information	pr	Hz	–					
	sr	Hz	26.76					
	$n_{pps}$		1					
	$I_{pa,\alpha}$ at $z_{pii,\alpha}$	W/cm <sup>2</sup>	–					
	$I_{spta,\alpha}$ at $z_{pii,\alpha}$ or $z_{sii,\alpha}$	mW/cm <sup>2</sup>	15.21					
	$I_{spta}$ at $z_{pii}$ or $z_{sii}$	mW/cm <sup>2</sup>	35.24					
	$p_r$ at $z_{pii}$	Mpa	–					
Operating Control Conditions	Focus	cm	6.50	4.50		4.50		–
	Power	%	100	100		100		–

NOTE 1 Only one operating condition per index.

NOTE 2 Data should be entered for “at surface” and “below surface” both in the columns related to TIS or TIB.

NOTE 3 Information need not be provided regarding TIC for any TRANSDUCER ASSEMBLY not intended for transcranial or neonatal cephalic uses.

NOTE 4 If the requirements of 201.12.4.2a) are met, it is not required to enter any data in the columns related to TIS, TIB or TIC.

NOTE 5 If the requirements of 201.12.4.2b) are met, it is not required to enter any data in the column related to MI.

NOTE 6 The depths  $z_{pii}$  and  $z_{pii,\alpha}$  apply to NON-SCANNING MODES, while the depths  $z_{sii}$  and  $z_{sii,\alpha}$  apply to SCANNING MODES.

**Transducer Model: V6-A**

**Operating Mode: PW**

Index label			MI	TIS		TIB		TIC
				At surface	Below surface	At surface	Below surface	
Maximum index value			0.30	0.10		0.10		–
Index component value				0.06	0.10	0.09	0.10	
Acoustic Parameter s	$p_{r,\alpha}$ at $Z_{MI}$	Mpa	0.84					
	P	mW		2.00		2.00		–
	$P_{1 \times 1}$	mW		0.69		0.69		
	$Z_s$	cm			3.24			
	$Z_b$	cm					3.30	
	$Z_{MI}$	cm	3.44					
	$z_{pii,\alpha}$	cm	3.47					
	$f_{awf}$	MHz	6.30	6.30		6.30		–
Other Informatio n	pr	Hz	3424.7 0					
	srr	Hz	–					
	$n_{pps}$		1					
	$I_{pa,\alpha}$ at $z_{pii,\alpha}$	W/cm <sup>2</sup>	27.45					
	$I_{spta,\alpha}$ at $z_{pii,\alpha}$ or $z_{sii,\alpha}$	mW/cm <sup>2</sup>	28.65					
	$I_{spta}$ at $z_{pii}$ or $z_{sii}$	mW/cm <sup>2</sup>	50.23					
$p_r$ at $z_{pii}$	Mpa	1.84						
Operating Control Conditons	Focus	cm	1.50	1.50		1.50		–
	Power	%	100	100		100		–

NOTE 1 Only one operating condition per index.

NOTE 2 Data should be entered for “at surface” and “below surface” both in the columns related to TIS or TIB.

NOTE 3 Information need not be provided regarding TIC for any TRANSDUCER ASSEMBLY not intended for transcranial or neonatal cephalic uses.

NOTE 4 If the requirements of 201.12.4.2a) are met, it is not required to enter any data in the columns related to TIS, TIB or TIC.

NOTE 5 If the requirements of 201.12.4.2b) are met, it is not required to enter any data in the column related to MI.

NOTE 6 The depths  $z_{pii}$  and  $z_{pii,\alpha}$  apply to NON-SCANNING MODES, while the depths  $z_{sij}$  and  $z_{sij,\alpha}$  apply to SCANNING MODES.

**Transducer Model: L7M-A**

**Operating Mode: B**

Index label			MI	TIS		TIB		TIC
				At surface	Below surface	At surface	Below surface	
Maximum index value			0.30	0.10		0.10		–
Index component value				0.10	0.10	0.09	0.10	
Acoustic Parameter s	$p_{r,\alpha}$ at $Z_{MI}$	Mpa	0.70					
	P	mW		16.00		16.00		–
	$P_{1 \times 1}$	mW		3.92		3.92		
	$Z_s$	cm			–			
	$Z_b$	cm					–	
	$Z_{MI}$	cm	1.93					
	$z_{pii,\alpha}$	cm	–					
	$f_{awf}$	MHz	7.23	7.21		7.21		–
Other Informatio n	prr	Hz	–					
	srr	Hz	30.05					
	$n_{pps}$		1					
	$I_{pa,\alpha}$ at $z_{pii,\alpha}$	W/cm <sup>2</sup>	–					
	$I_{spta,\alpha}$ at $z_{pii,\alpha}$ or $z_{sij,\alpha}$	mW/cm <sup>2</sup>	33.46					
	$I_{spta}$ at $z_{pii}$ or $z_{sij}$	mW/cm <sup>2</sup>	55.24					
	$p_r$ at $z_{pii}$	Mpa	–					
Operating Control Conditons	Focus	cm	2.00	6.00		6.00		–
	Power	%	100	100		100		–

NOTE 1 Only one operating condition per index.

NOTE 2 Data should be entered for “at surface” and “below surface” both in the columns related to TIS or TIB.



NOTE 3 Information need not be provided regarding TIC for any TRANSDUCER ASSEMBLY not intended for transcranial or neonatal cephalic uses.

NOTE 4 If the requirements of 201.12.4.2a) are met, it is not required to enter any data in the columns related to TIS, TIB or TIC.

NOTE 5 If the requirements of 201.12.4.2b) are met, it is not required to enter any data in the column related to MI.

NOTE 6 The depths  $z_{pii}$  and  $z_{pii,\alpha}$  apply to NON-SCANNING MODES, while the depths  $z_{sij}$  and  $z_{sij,\alpha}$  apply to SCANNING MODES.

**Transducer Model:** L7M-A

**Operating Mode:** THI-B

Index label			MI	TIS		TIB		TIC
				At surface	Below surface	At surface	Below surface	
Maximum index value			0.70	0.10		0.10		–
Index component value				0.10	0.10	0.06	0.10	
Acoustic Parameters	$p_{r,\alpha}$ at $Z_{MI}$	Mpa	0.69					
	P	mW		2.00		2.00		–
	$P_{1x1}$	mW		0.49		0.49		
	$Z_s$	cm			–			
	$Z_b$	cm					–	
	$Z_{MI}$	cm	1.33					
	$z_{pii,\alpha}$	cm	–					
	$f_{awf}$	MHz	6.85	6.85		6.85		–
Other Information	prr	Hz	–					
	srr	Hz	31.89					
	$n_{pps}$		1					
	$I_{pa,\alpha}$ at $z_{pii,\alpha}$	W/cm <sup>2</sup>	–					
	$I_{spta,\alpha}$ at $z_{pii,\alpha}$ or $z_{sij,\alpha}$	mW/cm <sup>2</sup>	103.32					
	$I_{spta}$ at $z_{pii}$ or $z_{sij}$	mW/cm <sup>2</sup>	125.26					
	$p_r$ at $z_{pii}$	Mpa	–					
Operating Control Conditions	Focus	cm	3.00	3.00		3.00		–
	Power	%	100	100		100		–

NOTE 1 Only one operating condition per index.

NOTE 2 Data should be entered for “at surface” and “below surface” both in the columns related to TIS or TIB.

NOTE 3 Information need not be provided regarding TIC for any TRANSDUCER ASSEMBLY not intended for transcranial or neonatal cephalic uses.

NOTE 4 If the requirements of 201.12.4.2a) are met, it is not required to enter any data in the columns related to TIS, TIB or TIC.

NOTE 5 If the requirements of 201.12.4.2b) are met, it is not required to enter any data in the column related to MI.

NOTE 6 The depths  $z_{pii}$  and  $z_{pii,\alpha}$  apply to NON-SCANNING MODES, while the depths  $z_{sij}$  and  $z_{sij,\alpha}$  apply to SCANNING MODES.

**Transducer Model:** L7M-A

**Operating Mode:** B+M

Index label			MI	TIS		TIB		TIC
				At surface	Below surface	At surface	Below surface	
Maximum index value			0.30	0.30		0.10		—
Index component value				0.22	0.30	0.07	0.10	
Acoustic Parameters	$p_{r,\alpha}$ at $Z_{MI}$	Mpa	0.83					
	P	mW		10.00		10.00		—
	$P_{1x1}$	mW		2.45		2.45		
	$Z_s$	cm			1.22			
	$Z_b$	cm					1.30	
	$Z_{MI}$	cm	1.33					
	$z_{pii,\alpha}$	cm	1.40					
	$f_{awf}$	MHz	6.86	6.85		6.82		—
Other Information	prr	Hz	668.90					
	srr	Hz	5.23					
	$n_{pps}$		1					
	$I_{pa,\alpha}$ at $z_{pii,\alpha}$	W/cm <sup>2</sup>	34.41					
	$I_{spta,\alpha}$ at $z_{pii,\alpha}$ or $z_{sij,\alpha}$	mW/cm <sup>2</sup>	33.12					
	$I_{spta}$ at $z_{pii}$ or $z_{sij}$	mW/cm <sup>2</sup>	53.41					
	$p_r$ at $z_{pii}$	Mpa	1.12					
Operating Control Conditions	Focus	cm	4.00	7.50		3.50		—
	Power	%	100	100		100		—

NOTE 1 Only one operating condition per index.

NOTE 2 Data should be entered for “at surface” and “below surface” both in the columns related to TIS or TIB.

NOTE 3 Information need not be provided regarding TIC for any TRANSDUCER ASSEMBLY not intended for transcranial or neonatal cephalic uses.

NOTE 4 If the requirements of 201.12.4.2a) are met, it is not required to enter any data in the columns related to TIS, TIB or TIC.

NOTE 5 If the requirements of 201.12.4.2b) are met, it is not required to enter any data in the column related to MI.

NOTE 6 The depths  $z_{pii}$  and  $z_{pii,\alpha}$  apply to NON-SCANNING MODES, while the depths  $z_{sij}$  and  $z_{sij,\alpha}$  apply to SCANNING MODES.

**Transducer Model:** L7M-A  
**Operating Mode:** THI-B+M

Index label			MI	TIS		TIB		TIC
				At surface	Below surface	At surface	Below surface	
Maximum index value			0.30	0.30		0.10		—
Index component value				0.25	0.30	0.09	0.10	
Acoustic Parameters	$p_{r,\alpha}$ at $Z_{MI}$	Mpa	0.83					
	P	mW		10.00		10.00		—
	$P_{1 \times 1}$	mW		2.45		2.45		
	$Z_s$	cm			1.19			
	$Z_b$	cm					1.30	
	$Z_{MI}$	cm	1.35					
	$z_{pii,\alpha}$	cm	1.40					
	$f_{awf}$	MHz	6.84	6.83		6.82		—
Other Information	prr	Hz	668.90					
	srr	Hz	5.23					
	$n_{pps}$		1					
	$I_{pa,\alpha}$ at $z_{pii,\alpha}$	W/cm <sup>2</sup>	34.38					
	$I_{spta,\alpha}$ at $z_{pii,\alpha}$ or $z_{sij,\alpha}$	mW/cm <sup>2</sup>	35.33					
	$I_{spta}$ at $z_{pii}$ or $z_{sij}$	mW/cm <sup>2</sup>	53.24					
$p_r$ at $z_{pii}$	Mpa	1.12						
Operating Control Conditions	Focus	cm	4.00	7.50		3.50		—
	Power	%	100	100		100		—

NOTE 1 Only one operating condition per index.

NOTE 2 Data should be entered for “at surface” and “below surface” both in the columns related to TIS or TIB.

NOTE 3 Information need not be provided regarding TIC for any TRANSDUCER ASSEMBLY not intended for transcranial or neonatal cephalic uses.

NOTE 4 If the requirements of 201.12.4.2a) are met, it is not required to enter any data in the columns related to TIS, TIB or TIC.

NOTE 5 If the requirements of 201.12.4.2b) are met, it is not required to enter any data in the column related to MI.

NOTE 6 The depths  $z_{pii}$  and  $z_{pii,\alpha}$  apply to NON-SCANNING MODES, while the depths  $z_{sij}$  and  $z_{sij,\alpha}$  apply to SCANNING MODES.

**Transducer Model:** L7M-A

**Operating Mode:** B+C

Index label			MI	TIS		TIB		TIC
				At surface	Below surface	At surface	Below surface	
Maximum index value			0.40	0.20		0.20		–
Index component value				0.20	0.20	0.14	0.20	
Acoustic Parameters	$p_{r,\alpha}$ at $Z_{MI}$	Mpa	1.09					
	P	mW		16.00		16.00		–
	$P_{1x1}$	mW		3.92		3.92		
	$Z_s$	cm			–			
	$Z_b$	cm					–	
	$Z_{MI}$	cm	1.22					
	$z_{pii,\alpha}$	cm	–					
	$f_{awf}$	MHz	7.87	7.87		7.87		–
Other Information	prr	Hz	–					
	srr	Hz	47.63					
	$n_{pps}$		1					
	$I_{pa,\alpha}$ at $z_{pii,\alpha}$	W/cm <sup>2</sup>	–					
	$I_{spta,\alpha}$ at $z_{pii,\alpha}$ or $z_{sij,\alpha}$	mW/cm <sup>2</sup>	38.88					
	$I_{spta}$ at $z_{pii}$ or $z_{sij}$	mW/cm <sup>2</sup>	60.23					
	$p_r$ at $z_{pii}$	Mpa	–					
Operating Control Conditions	Focus	cm	1.00	1.00		1.00		–
	Power	%	100	100		100		–

NOTE 1 Only one operating condition per index.

NOTE 2 Data should be entered for “at surface” and “below surface” both in the columns related to TIS or TIB.

NOTE 3 Information need not be provided regarding TIC for any TRANSDUCER ASSEMBLY not intended for transcranial or neonatal cephalic uses.

NOTE 4 If the requirements of 201.12.4.2a) are met, it is not required to enter any data in the columns related to TIS, TIB or TIC.

NOTE 5 If the requirements of 201.12.4.2b) are met, it is not required to enter any data in the column related to MI.

NOTE 6 The depths  $z_{pii}$  and  $z_{pii,\alpha}$  apply to NON-SCANNING MODES, while the depths  $z_{sii}$  and  $z_{sii,\alpha}$  apply to SCANNING MODES.

**Transducer Model:** L7M-A

**Operating Mode:** PW

Index label			MI	TIS		TIB		TIC
				At surface	Below surface	At surface	Below surface	
Maximum index value			0.80	0.90		0.80		–
Index component value				0.84	0.90	0.74	0.80	
Acoustic Parameters	$p_{r,\alpha}$ at $Z_{MI}$	Mpa	1.98					
	P	mW		34.00		34.00		–
	$P_{1 \times 1}$	mW		8.33		8.33		
	$Z_s$	cm			1.44			
	$Z_b$	cm					1.50	
	$Z_{MI}$	cm	3.33					
	$z_{pii,\alpha}$	cm	3.35					
	$f_{awf}$	MHz	6.87	6.83		6.83		–
Other Information	prr	Hz	6970.00					
	srr	Hz	–					
	$n_{pps}$		1					
	$I_{pa,\alpha}$ at $z_{pii,\alpha}$	W/cm <sup>2</sup>	179.38					
	$I_{spta,\alpha}$ at $z_{pii,\alpha}$ or $z_{sii,\alpha}$	mW/cm <sup>2</sup>	177.65					
	$I_{spta}$ at $z_{pii}$ or $z_{sii}$	mW/cm <sup>2</sup>	200.32					
$p_r$ at $z_{pii}$	Mpa	3.17						
Operating Control Conditions	Focus	cm	6.50	3.50		3.50		–
	Power	%	100	100		100		–

NOTE 1 Only one operating condition per index.

NOTE 2 Data should be entered for “at surface” and “below surface” both in the columns related to TIS or TIB.

NOTE 3 Information need not be provided regarding TIC for any TRANSDUCER ASSEMBLY not intended for transcranial or neonatal cephalic uses.

NOTE 4 If the requirements of 201.12.4.2a) are met, it is not required to enter any data in the columns related to TIS, TIB or TIC.

NOTE 5 If the requirements of 201.12.4.2b) are met, it is not required to enter any data in the column related to MI.

NOTE 6 The depths  $z_{pii}$  and  $z_{pii,\alpha}$  apply to NON-SCANNING MODES, while the depths  $z_{sij}$  and  $z_{sij,\alpha}$  apply to SCANNING MODES.

**Transducer Model: MC3-A**

**Operating Mode: B**

Index label			MI	TIS		TIB		TIC
				At surface	Below surface	At surface	Below surface	
Maximum index value			0.40	0.10		0.10		–
Index component value				0.10	0.10	0.09	0.10	
Acoustic Parameters	$p_{r,\alpha}$ at $Z_{MI}$	Mpa	0.72					
	P	mW		4.32		4.32		–
	$P_{1 \times 1}$	mW		1.13		1.13		
	$Z_s$	cm			–			
	$Z_b$	cm					–	
	$Z_{MI}$	cm	3.33					
	$z_{pii,\alpha}$	cm	–					
	$f_{awf}$	MHz	3.20	3.54		3.54		–
Other Information	prr	Hz	–					
	srr	Hz	17.96					
	$n_{pps}$		1					
	$I_{pa,\alpha}$ at $z_{pii,\alpha}$	W/cm <sup>2</sup>	–					
	$I_{spta,\alpha}$ at $z_{pii,\alpha}$ or $z_{sij,\alpha}$	mW/cm <sup>2</sup>	15.54					
	$I_{spta}$ at $z_{pii}$ or $z_{sij}$	mW/cm <sup>2</sup>	33.64					
	$p_r$ at $z_{pii}$	Mpa	–					
Operating Control Conditions	Focus	cm	7.00	3.00		3.00		–
	Power	%	100	100		100		–

NOTE 1 Only one operating condition per index.

NOTE 2 Data should be entered for “at surface” and “below surface” both in the columns related to TIS or TIB.

NOTE 3 Information need not be provided regarding TIC for any TRANSDUCER ASSEMBLY not intended for transcranial or neonatal cephalic uses.

NOTE 4 If the requirements of 201.12.4.2a) are met, it is not required to enter any data in the columns related to TIS, TIB or TIC.

NOTE 5 If the requirements of 201.12.4.2b) are met, it is not required to enter any data in the column related to MI.

NOTE 6 The depths  $z_{pii}$  and  $z_{pii,\alpha}$  apply to NON-SCANNING MODES, while the depths  $z_{sii}$  and  $z_{sii,\alpha}$  apply to SCANNING MODES.

**Transducer Model: MC3-A**

**Operating Mode: THI-B**

Index label			MI	TIS		TIB		TIC
				At surface	Below surface	At surface	Below surface	
Maximum index value			0.40	0.10		0.10		–
Index component value				0.10	0.10	0.06	0.10	
Acoustic Parameter s	$p_{r,\alpha}$ at $Z_{MI}$	Mpa	0.69					
	P	mW		4.32		4.32		–
	$P_{1 \times 1}$	mW		1.13		1.13		
	$Z_s$	cm			–			
	$Z_b$	cm					–	
	$Z_{MI}$	cm	3.33					
	$z_{pii,\alpha}$	cm	–					
	$f_{awf}$	MHz	2.95	2.96		2.96		–
Other Informatio n	$p_{rr}$	Hz	–					
	$s_{rr}$	Hz	17.96					
	$n_{pps}$		1					
	$I_{pa,\alpha}$ at $z_{pii,\alpha}$	W/cm <sup>2</sup>	–					
	$I_{spta,\alpha}$ at $z_{pii,\alpha}$ or $z_{sii,\alpha}$	mW/cm <sup>2</sup>	11.32					
	$I_{spta}$ at $z_{pii}$ or $z_{sii}$	mW/cm <sup>2</sup>	34.65					
	$p_r$ at $z_{pii}$	Mpa	–					
Operating Control Conditons	Focus	cm	7.00	3.00		3.00		–
	Power	%	100	100		100		–

NOTE 1 Only one operating condition per index.

NOTE 2 Data should be entered for “at surface” and “below surface” both in the columns related to TIS or TIB.

NOTE 3 Information need not be provided regarding TIC for any TRANSDUCER ASSEMBLY not intended for transcranial or neonatal cephalic uses.

NOTE 4 If the requirements of 201.12.4.2a) are met, it is not required to enter any data in the columns related to TIS, TIB or TIC.

NOTE 5 If the requirements of 201.12.4.2b) are met, it is not required to enter any data in the column related to MI.

NOTE 6 The depths  $z_{pii}$  and  $z_{pii,\alpha}$  apply to NON-SCANNING MODES, while the depths  $z_{sii}$  and  $z_{sii,\alpha}$  apply to SCANNING MODES.

**Transducer Model: MC3-A**

**Operating Mode: B+M**

Index label			MI	TIS		TIB		TIC
				At surface	Below surface	At surface	Below surface	
Maximum index value			0.40	0.10		0.10		—
Index component value				0.08	0.10	0.07	0.10	
Acoustic Parameter s	$p_{r,\alpha}$ at $Z_{MI}$	Mpa	0.69					
	P	mW		2.00		2.00		—
	$P_{1 \times 1}$	mW		0.52		0.52		
	$Z_s$	cm			2.00			
	$Z_b$	cm					3.45	
	$Z_{MI}$	cm	3.33					
	$z_{pii,\alpha}$	cm	3.45					
	$f_{awf}$	MHz	2.95	2.95		2.95		—
Other Informatio n	prr	Hz	668.90					
	srr	Hz	5.23					
	$n_{pps}$		1					
	$I_{pa,\alpha}$ at $z_{pii,\alpha}$	W/cm <sup>2</sup>	14.70					
	$I_{spta,\alpha}$ at $z_{pii,\alpha}$ or $z_{sii,\alpha}$	mW/cm <sup>2</sup>	15.80					
	$I_{spta}$ at $z_{pii}$ or $z_{sii}$	mW/cm <sup>2</sup>	34.60					
	$p_r$ at $z_{pii}$	Mpa	1.03					
Operating Control Conditons	Focus	cm	7.00	7.00		7.00		—
	Power	%	100	100		100		—

NOTE 1 Only one operating condition per index.

NOTE 2 Data should be entered for “at surface” and “below surface” both in the columns related to TIS or TIB.



NOTE 3 Information need not be provided regarding TIC for any TRANSDUCER ASSEMBLY not intended for transcranial or neonatal cephalic uses.

NOTE 4 If the requirements of 201.12.4.2a) are met, it is not required to enter any data in the columns related to TIS, TIB or TIC.

NOTE 5 If the requirements of 201.12.4.2b) are met, it is not required to enter any data in the column related to MI.

NOTE 6 The depths  $z_{pii}$  and  $z_{pii,\alpha}$  apply to NON-SCANNING MODES, while the depths  $z_{sii}$  and  $z_{sii,\alpha}$  apply to SCANNING MODES.

**Transducer Model: MC3-A**

**Operating Mode: THI-B+M**

Index label			MI	TIS		TIB		TIC
				At surface	Below surface	At surface	Below surface	
Maximum index value			0.30	0.10		0.10		–
Index component value				0.05	0.10	0.09	0.10	
Acoustic Parameter s	$p_{r,\alpha}$ at $Z_{MI}$	Mpa	0.51					
	P	mW		2.00		2.00		–
	$P_{1 \times 1}$	mW		0.52		0.52		
	$Z_s$	cm			2.00			
	$Z_b$	cm					3.45	
	$Z_{MI}$	cm	3.35					
	$z_{pii,\alpha}$	cm	3.42					
	$f_{awf}$	MHz	2.89	2.91		2.92		–
Other Informatio n	prr	Hz	668.90					
	srr	Hz	5.23					
	$n_{pps}$		1					
	$I_{pa,\alpha}$ at $z_{pii,\alpha}$	W/cm <sup>2</sup>	14.63					
	$I_{spta,\alpha}$ at $z_{pii,\alpha}$ or $z_{sii,\alpha}$	mW/cm <sup>2</sup>	13.62					
	$I_{spta}$ at $z_{pii}$ or $z_{sii}$	mW/cm <sup>2</sup>	34.56					
	$p_r$ at $z_{pii}$	Mpa	1.03					
Operating Control Conditons	Focus	cm	7.00	7.00		7.00		–
	Power	%	100	100		100		–

NOTE 1 Only one operating condition per index.

NOTE 2 Data should be entered for “at surface” and “below surface” both in the columns related to TIS or TIB.

NOTE 3 Information need not be provided regarding TIC for any TRANSDUCER ASSEMBLY not intended for transcranial or neonatal cephalic uses.

NOTE 4 If the requirements of 201.12.4.2a) are met, it is not required to enter any data in the columns related to TIS, TIB or TIC.

NOTE 5 If the requirements of 201.12.4.2b) are met, it is not required to enter any data in the column related to MI.

NOTE 6 The depths  $z_{pii}$  and  $z_{pii,\alpha}$  apply to NON-SCANNING MODES, while the depths  $z_{sii}$  and  $z_{sii,\alpha}$  apply to SCANNING MODES.

**Transducer Model: MC3-A**

**Operating Mode: B+C**

Index label			MI	TIS		TIB		TIC
				At surface	Below surface	At surface	Below surface	
Maximum index value			0.60	0.10		0.10		–
Index component value				0.10	0.10	0.09	0.10	
Acoustic Parameter s	$p_{r,\alpha}$ at $Z_{MI}$	Mpa	1.03					
	P	mW		12.00		12.00		–
	$P_{1x1}$	mW		3.13		3.13		
	$Z_s$	cm			–			
	$Z_b$	cm					–	
	$Z_{MI}$	cm	3.44					
	$z_{pii,\alpha}$	cm	–					
	$f_{awf}$	MHz	2.95	2.95		2.95		–
Other Informatio n	prr	Hz	–					
	srr	Hz	47.63					
	$n_{pps}$		1					
	$I_{pa,\alpha}$ at $z_{pii,\alpha}$	W/cm <sup>2</sup>	–					
	$I_{spta,\alpha}$ at $z_{pii,\alpha}$ or $z_{sii,\alpha}$	mW/cm <sup>2</sup>	44.54					
	$I_{spta}$ at $z_{pii}$ or $z_{sii}$	mW/cm <sup>2</sup>	65.52					
	$p_r$ at $z_{pii}$	Mpa	–					
Operating Control Conditons	Focus	cm	5.00	5.00		5.00		–
	Power	%	100	100		100		–

NOTE 1 Only one operating condition per index.

NOTE 2 Data should be entered for “at surface” and “below surface” both in the columns related to TIS or TIB.

NOTE 3 Information need not be provided regarding TIC for any TRANSDUCER ASSEMBLY not intended for transcranial or neonatal cephalic uses.

NOTE 4 If the requirements of 201.12.4.2a) are met, it is not required to enter any data in the columns related to TIS, TIB or TIC.

NOTE 5 If the requirements of 201.12.4.2b) are met, it is not required to enter any data in the column related to MI.

NOTE 6 The depths  $z_{pii}$  and  $z_{pii,\alpha}$  apply to NON-SCANNING MODES, while the depths  $z_{sii}$  and  $z_{sii,\alpha}$  apply to SCANNING MODES.

Transducer Model: MC3-A

Operating Mode: PW

Index label			MI	TIS		TIB		TIC
				At surface	Below surface	At surface	Below surface	
Maximum index value			0.50	0.30		0.40		–
Index component value				0.25	0.30	0.33	0.40	
Acoustic Parameters	$p_{r,\alpha}$ at $Z_{MI}$	Mpa	0.81					
	P	mW		10.00		10.00		–
	$P_{1x1}$	mW		2.60		2.60		
	$Z_s$	cm			3.54			
	$Z_b$	cm					3.65	
	$Z_{MI}$	cm	3.44					
	$z_{pii,\alpha}$	cm	3.55					
	$f_{awf}$	MHz	2.58	2.58		2.58		–
Other Information	pr	Hz	6098.0 0					
	srr	Hz	–					
	$n_{pps}$		1					
	$I_{pa,\alpha}$ at $z_{pii,\alpha}$	W/cm <sup>2</sup>	23.63					
	$I_{spta,\alpha}$ at $z_{pii,\alpha}$ or $z_{sii,\alpha}$	mW/cm <sup>2</sup>	25.65					
	$I_{spta}$ at $z_{pii}$ or $z_{sii}$	mW/cm <sup>2</sup>	44.54					
$p_r$ at $z_{pii}$	Mpa	1.41						
Operating Control Conditions	Focus	cm	3.00	3.00		3.00		–
	Power	%	100	100		100		–

NOTE 1 Only one operating condition per index.

NOTE 2 Data should be entered for “at surface” and “below surface” both in the columns related to

TIS or TIB.

NOTE 3 Information need not be provided regarding TIC for any TRANSDUCER ASSEMBLY not intended for transcranial or neonatal cephalic uses.

NOTE 4 If the requirements of 201.12.4.2a) are met, it is not required to enter any data in the columns related to TIS, TIB or TIC.

NOTE 5 If the requirements of 201.12.4.2b) are met, it is not required to enter any data in the column related to MI.

NOTE 6 The depths  $z_{pii}$  and  $z_{pii,\alpha}$  apply to NON-SCANNING MODES, while the depths  $z_{sij}$  and  $z_{sij,\alpha}$  apply to SCANNING MODES.

**Transducer Model: R7-A**

**Operating Mode: B**

Index label			MI	TIS		TIB		TIC
				At surface	Below surface	At surface	Below surface	
Maximum index value			0.30	0.10		0.10		–
Index component value				0.10	0.10	0.08	0.10	
Acoustic Parameters	$p_{r,\alpha}$ at $Z_{MI}$	Mpa	0.81					
	P	mW		16.00		16.00		–
	$P_{1 \times 1}$	mW		3.92		3.92		
	$Z_s$	cm			–			
	$Z_b$	cm					–	
	$Z_{MI}$	cm	1.88					
	$z_{pii,\alpha}$	cm	–					
	$f_{awf}$	MHz	7.23		7.21		7.21	
Other Information	pr	Hz	–					
	sr	Hz	30.05					
	$n_{pps}$		1					
	$I_{pa,\alpha}$ at $z_{pii,\alpha}$	W/cm <sup>2</sup>	–					
	$I_{spta,\alpha}$ at $z_{pii,\alpha}$ or $z_{sij,\alpha}$	mW/cm <sup>2</sup>	31.55					
	$I_{spta}$ at $z_{pii}$ or $z_{sij}$	mW/cm <sup>2</sup>	53.24					
$p_r$ at $z_{pii}$	Mpa	–						
Operating Control Conditions	Focus	cm	2.00	6.00		6.00		–
	Power	%	100	100		100		–

NOTE 1 Only one operating condition per index.

NOTE 2 Data should be entered for “at surface” and “below surface” both in the columns related to

TIS or TIB.

NOTE 3 Information need not be provided regarding TIC for any TRANSDUCER ASSEMBLY not intended for transcranial or neonatal cephalic uses.

NOTE 4 If the requirements of 201.12.4.2a) are met, it is not required to enter any data in the columns related to TIS, TIB or TIC.

NOTE 5 If the requirements of 201.12.4.2b) are met, it is not required to enter any data in the column related to MI.

NOTE 6 The depths  $z_{pii}$  and  $z_{pii,\alpha}$  apply to NON-SCANNING MODES, while the depths  $z_{sij}$  and  $z_{sij,\alpha}$  apply to SCANNING MODES.

**Transducer Model:** R7-A

**Operating Mode:** THI-B

Index label			MI	TIS		TIB		TIC
				At surface	Below surface	At surface	Below surface	
Maximum index value			0.30	0.10		0.10		–
Index component value				0.10	0.10	0.08	0.10	
Acoustic Parameters	$p_{r,\alpha}$ at $Z_{MI}$	Mpa	0.79					
	P	mW		2.00		2.00		–
	$P_{1 \times 1}$	mW		0.49		0.49		
	$Z_s$	cm			–			
	$Z_b$	cm					–	
	$Z_{MI}$	cm	1.33					
	$z_{pii,\alpha}$	cm	–					
	$f_{awf}$	MHz	6.85	6.85		6.85		–
Other Information	prr	Hz	–					
	srr	Hz	31.89					
	$\eta_{pps}$		1					
	$I_{pa,\alpha}$ at $z_{pii,\alpha}$	W/cm <sup>2</sup>	–					
	$I_{spta,\alpha}$ at $z_{pii,\alpha}$ or $z_{sij,\alpha}$	mW/cm <sup>2</sup>	103.25					
	$I_{spta}$ at $z_{pii}$ or $z_{sij}$	mW/cm <sup>2</sup>	125.32					
$p_r$ at $z_{pii}$	Mpa	–						
Operating Control Conditions	Focus	cm	3.00	3.00		3.00		–
	Power	%	100	100		100		–

NOTE 1 Only one operating condition per index.

NOTE 2 Data should be entered for “at surface” and “below surface” both in the columns related to

TIS or TIB.

NOTE 3 Information need not be provided regarding TIC for any TRANSDUCER ASSEMBLY not intended for transcranial or neonatal cephalic uses.

NOTE 4 If the requirements of 201.12.4.2a) are met, it is not required to enter any data in the columns related to TIS, TIB or TIC.

NOTE 5 If the requirements of 201.12.4.2b) are met, it is not required to enter any data in the column related to MI.

NOTE 6 The depths  $z_{pii}$  and  $z_{pii,\alpha}$  apply to NON-SCANNING MODES, while the depths  $z_{sij}$  and  $z_{sij,\alpha}$  apply to SCANNING MODES.

**Transducer Model: R7-A**

**Operating Mode: B+M**

Index label			MI	TIS		TIB		TIC
				At surface	Below surface	At surface	Below surface	
Maximum index value			0.30	0.30		0.10		–
Index component value				0.25	0.30	0.09	0.10	
Acoustic Parameters	$p_{r,\alpha}$ at $Z_{MI}$	Mpa	0.83					
	P	mW		10.00		10.00		–
	$P_{1 \times 1}$	mW		2.45		2.45		
	$Z_s$	cm			1.22			
	$Z_b$	cm					1.30	
	$Z_{MI}$	cm	1.33					
	$z_{pii,\alpha}$	cm	1.40					
	$f_{awf}$	MHz	6.86	6.85		6.82		–
Other Information	prr	Hz	668.90					
	srr	Hz	5.23					
	$\eta_{pps}$		1					
	$I_{pa,\alpha}$ at $z_{pii,\alpha}$	W/cm <sup>2</sup>	34.41					
	$I_{spta,\alpha}$ at $z_{pii,\alpha}$ or $z_{sij,\alpha}$	mW/cm <sup>2</sup>	35.52					
	$I_{spta}$ at $z_{pii}$ or $z_{sij}$	mW/cm <sup>2</sup>	46.21					
$p_r$ at $z_{pii}$	Mpa	1.12						
Operating Control Conditions	Focus	cm	4.00	7.50		3.50		–
	Power	%	100	100		100		–

NOTE 1 Only one operating condition per index.

NOTE 2 Data should be entered for “at surface” and “below surface” both in the columns related to

TIS or TIB.

NOTE 3 Information need not be provided regarding TIC for any TRANSDUCER ASSEMBLY not intended for transcranial or neonatal cephalic uses.

NOTE 4 If the requirements of 201.12.4.2a) are met, it is not required to enter any data in the columns related to TIS, TIB or TIC.

NOTE 5 If the requirements of 201.12.4.2b) are met, it is not required to enter any data in the column related to MI.

NOTE 6 The depths  $z_{pii}$  and  $z_{pii,\alpha}$  apply to NON-SCANNING MODES, while the depths  $z_{sij}$  and  $z_{sij,\alpha}$  apply to SCANNING MODES.

**Transducer Model:** R7-A

**Operating Mode:** THI-B+M

Index label			MI	TIS		TIB		TIC
				At surface	Below surface	At surface	Below surface	
Maximum index value			0.30	0.30		0.10		—
Index component value				0.25	0.30	0.05	0.10	
Acoustic Parameters	$p_{r,\alpha}$ at $Z_{MI}$	Mpa	0.83					
	P	mW		10.00		10.00		—
	$P_{1 \times 1}$	mW		2.45		2.45		
	$Z_s$	cm			1.25			
	$Z_b$	cm					1.30	
	$Z_{MI}$	cm	1.35					
	$z_{pii,\alpha}$	cm	1.40					
	$f_{awf}$	MHz	6.72	6.81		6.79		—
Other Information	prr	Hz	668.90					
	srr	Hz	5.23					
	$\eta_{pps}$		1					
	$I_{pa,\alpha}$ at $z_{pii,\alpha}$	W/cm <sup>2</sup>	34.22					
	$I_{spta,\alpha}$ at $z_{pii,\alpha}$ or $z_{sij,\alpha}$	mW/cm <sup>2</sup>	35.52					
	$I_{spta}$ at $z_{pii}$ or $z_{sij}$	mW/cm <sup>2</sup>	56.44					
$p_r$ at $z_{pii}$	Mpa	1.12						
Operating Control Conditions	Focus	cm	4.00	7.50		3.50		—
	Power	%	100	100		100		—

NOTE 1 Only one operating condition per index.

NOTE 2 Data should be entered for “at surface” and “below surface” both in the columns related to

TIS or TIB.

NOTE 3 Information need not be provided regarding TIC for any TRANSDUCER ASSEMBLY not intended for transcranial or neonatal cephalic uses.

NOTE 4 If the requirements of 201.12.4.2a) are met, it is not required to enter any data in the columns related to TIS, TIB or TIC.

NOTE 5 If the requirements of 201.12.4.2b) are met, it is not required to enter any data in the column related to MI.

NOTE 6 The depths  $z_{pii}$  and  $z_{pii,\alpha}$  apply to NON-SCANNING MODES, while the depths  $z_{sij}$  and  $z_{sij,\alpha}$  apply to SCANNING MODES.

**Transducer Model:** R7-A

**Operating Mode:** B+C

Index label			MI	TIS		TIB		TIC
				At surface	Below surface	At surface	Below surface	
Maximum index value			0.40	0.20		0.20		–
Index component value				0.20	0.20	0.11	0.20	
Acoustic Parameters	$p_{r,\alpha}$ at $Z_{MI}$	Mpa	1.09					
	P	mW		16.00		16.00		–
	$P_{1 \times 1}$	mW		3.92		3.92		
	$Z_s$	cm			–			
	$Z_b$	cm					–	
	$Z_{MI}$	cm	1.22					
	$z_{pii,\alpha}$	cm	–					
	$f_{awf}$	MHz	7.87	7.87		7.87		–
Other Information	prr	Hz	–					
	srr	Hz	47.63					
	$\eta_{pps}$		1					
	$I_{pa,\alpha}$ at $z_{pii,\alpha}$	W/cm <sup>2</sup>	–					
	$I_{spta,\alpha}$ at $z_{pii,\alpha}$ or $z_{sij,\alpha}$	mW/cm <sup>2</sup>	36.65					
	$I_{spta}$ at $z_{pii}$ or $z_{sij}$	mW/cm <sup>2</sup>	55.23					
$p_r$ at $z_{pii}$	Mpa	–						
Operating Control Conditions	Focus	cm	1.00	1.00		1.00		–
	Power	%	100	100		100		–

NOTE 1 Only one operating condition per index.

NOTE 2 Data should be entered for “at surface” and “below surface” both in the columns related to



TIS or TIB.

NOTE 3 Information need not be provided regarding TIC for any TRANSDUCER ASSEMBLY not intended for transcranial or neonatal cephalic uses.

NOTE 4 If the requirements of 201.12.4.2a) are met, it is not required to enter any data in the columns related to TIS, TIB or TIC.

NOTE 5 If the requirements of 201.12.4.2b) are met, it is not required to enter any data in the column related to MI.

NOTE 6 The depths  $z_{pii}$  and  $z_{pii,\alpha}$  apply to NON-SCANNING MODES, while the depths  $z_{sij}$  and  $z_{sij,\alpha}$  apply to SCANNING MODES.

**Transducer Model: R7-A**

**Operating Mode: PW**

Index label			MI	TIS		TIB		TIC
				At surface	Below surface	At surface	Below surface	
Maximum index value			0.80	0.90		0.80		–
Index component value				0.87	0.90	0.77	0.80	
Acoustic Parameters	$p_{r,\alpha}$ at $Z_{MI}$	Mpa	1.98					
	P	mW		34.00		34.00		–
	$P_{1x1}$	mW		8.33		8.33		
	$Z_s$	cm			1.46			
	$Z_b$	cm					1.50	
	$Z_{MI}$	cm	3.33					
	$z_{pii,\alpha}$	cm	3.35					
	$f_{awf}$	MHz	6.87	6.83		6.83		–
Other Information	prr	Hz	6970.00					
	srr	Hz	–					
	$n_{pps}$		1					
	$I_{pa,\alpha}$ at $z_{pii,\alpha}$	W/cm <sup>2</sup>	179.38					
	$I_{spta,\alpha}$ at $z_{pii,\alpha}$ or $z_{sij,\alpha}$	mW/cm <sup>2</sup>	180.23					
	$I_{spta}$ at $z_{pii}$ or $z_{sij}$	mW/cm <sup>2</sup>	203.26					
$p_r$ at $z_{pii}$	Mpa	3.17						
Operating Control Conditions	Focus	cm	6.50	3.50		3.50		–
	Power	%	100	100		100		–

NOTE 1 Only one operating condition per index.

NOTE 2 Data should be entered for “at surface” and “below surface” both in the columns related to

TIS or TIB.

NOTE 3 Information need not be provided regarding TIC for any TRANSDUCER ASSEMBLY not intended for transcranial or neonatal cephalic uses.

NOTE 4 If the requirements of 201.12.4.2a) are met, it is not required to enter any data in the columns related to TIS, TIB or TIC.

NOTE 5 If the requirements of 201.12.4.2b) are met, it is not required to enter any data in the column related to MI.

NOTE 6 The depths  $z_{pii}$  and  $z_{pii,\alpha}$  apply to NON-SCANNING MODES, while the depths  $z_{sij}$  and  $z_{sij,\alpha}$  apply to SCANNING MODES.

**Transducer Model: MC6-A**

**Operating Mode: B**

Index label			MI	TIS		TIB		TIC
				At surface	Below surface	At surface	Below surface	
Maximum index value			0.80	0.10		0.10		–
Index component value				0.10	0.10	0.08	0.10	
Acoustic Parameter s	$p_{r,\alpha}$ at $Z_{MI}$	Mpa	1.94					
	P	mW		18.00		18.00		–
	$P_{1 \times 1}$	mW		7.50		7.50		
	$Z_s$	cm			–			
	$Z_b$	cm					–	
	$Z_{MI}$	cm	3.14					
	$z_{pii,\alpha}$	cm	–					
	$f_{awf}$	MHz	5.86	5.89		5.89		–
Other Informatio n	prr	Hz	–					
	srr	Hz	37.92					
	$n_{pps}$		1					
	$I_{pa,\alpha}$ at $z_{pii,\alpha}$	W/cm <sup>2</sup>	–					
	$I_{spta,\alpha}$ at $z_{pii,\alpha}$ or $z_{sij,\alpha}$	mW/cm <sup>2</sup>	88.45					
	$I_{spta}$ at $z_{pii}$ or $z_{sij}$	mW/cm <sup>2</sup>	105.23					
	$p_r$ at $z_{pii}$	Mpa	–					
Operating Control Conditons	Focus	cm	3.00	6.50		6.50		–
	Power	%	100	100		100		–

NOTE 1 Only one operating condition per index.

NOTE 2 Data should be entered for “at surface” and “below surface” both in the columns related to

TIS or TIB.

NOTE 3 Information need not be provided regarding TIC for any TRANSDUCER ASSEMBLY not intended for transcranial or neonatal cephalic uses.

NOTE 4 If the requirements of 201.12.4.2a) are met, it is not required to enter any data in the columns related to TIS, TIB or TIC.

NOTE 5 If the requirements of 201.12.4.2b) are met, it is not required to enter any data in the column related to MI.

NOTE 6 The depths  $z_{pii}$  and  $z_{pii,\alpha}$  apply to NON-SCANNING MODES, while the depths  $z_{sii}$  and  $z_{sii,\alpha}$  apply to SCANNING MODES.

**Transducer Model: MC6-A**

**Operating Mode: B+M**

Index label			MI	TIS		TIB		TIC
				At surface	Below surface	At surface	Below surface	
Maximum index value			0.30	0.40		0.10		—
Index component value				0.32	0.40	0.06	0.10	
Acoustic Parameters	$p_{r,\alpha}$ at $Z_{MI}$	Mpa	0.61					
	P	mW		16.00		16.00		—
	$P_{1x1}$	mW		6.67		6.67		
	$Z_s$	cm			1.93			
	$Z_b$	cm					1.95	
	$Z_{MI}$	cm	1.99					
	$z_{pii,\alpha}$	cm	2.05					
	$f_{awf}$	MHz	5.56	5.46		5.46		—
Other Information	prr	Hz	400.00					
	srr	Hz	3.13					
	$n_{pps}$		1					
	$I_{pa,\alpha}$ at $z_{pii,\alpha}$	W/cm <sup>2</sup>	12.25					
	$I_{spta,\alpha}$ at $z_{pii,\alpha}$ or $z_{sii,\alpha}$	mW/cm <sup>2</sup>	15.80					
	$I_{spta}$ at $z_{pii}$ or $z_{sii}$	mW/cm <sup>2</sup>	34.62					
	$p_r$ at $z_{pii}$	Mpa	0.75					
Operating Control Conditions	Focus	cm	3.00	5.00		5.00		—
	Power	%	100	100		100		—

NOTE 1 Only one operating condition per index.

NOTE 2 Data should be entered for “at surface” and “below surface” both in the columns related to

TIS or TIB.

NOTE 3 Information need not be provided regarding TIC for any TRANSDUCER ASSEMBLY not intended for transcranial or neonatal cephalic uses.

NOTE 4 If the requirements of 201.12.4.2a) are met, it is not required to enter any data in the columns related to TIS, TIB or TIC.

NOTE 5 If the requirements of 201.12.4.2b) are met, it is not required to enter any data in the column related to MI.

NOTE 6 The depths  $z_{pii}$  and  $z_{pii,\alpha}$  apply to NON-SCANNING MODES, while the depths  $z_{sii}$  and  $z_{sii,\alpha}$  apply to SCANNING MODES.

**Transducer Model: MC6-A**

**Operating Mode: THI-B+M**

Index label			MI	TIS		TIB		TIC
				At surface	Below surface	At surface	Below surface	
Maximum index value			0.30	0.40		0.10		—
Index component value				0.31	0.40	0.08	0.10	
Acoustic Parameters	$p_{r,\alpha}$ at $Z_{MI}$	Mpa	0.61					
	P	mW		16.00		16.00		—
	$P_{1x1}$	mW		6.67		6.67		
	$Z_s$	cm			1.92			
	$Z_b$	cm					1.95	
	$Z_{MI}$	cm	1.99					
	$z_{pii,\alpha}$	cm	2.05					
	$f_{awf}$	MHz	5.52		5.43		5.45	
Other Information	prr	Hz	400.00					
	srr	Hz	3.13					
	$n_{pps}$		1					
	$I_{pa,\alpha}$ at $z_{pii,\alpha}$	W/cm <sup>2</sup>	12.21					
	$I_{spta,\alpha}$ at $z_{pii,\alpha}$ or $z_{sii,\alpha}$	mW/cm <sup>2</sup>	13.32					
	$I_{spta}$ at $z_{pii}$ or $z_{sii}$	mW/cm <sup>2</sup>	35.21					
$p_r$ at $z_{pii}$	Mpa	0.75						
Operating Control Conditions	Focus	cm	3.00	5.00		5.00		—
	Power	%	100	100		100		—

NOTE 1 Only one operating condition per index.

NOTE 2 Data should be entered for “at surface” and “below surface” both in the columns related to

TIS or TIB.

NOTE 3 Information need not be provided regarding TIC for any TRANSDUCER ASSEMBLY not intended for transcranial or neonatal cephalic uses.

NOTE 4 If the requirements of 201.12.4.2a) are met, it is not required to enter any data in the columns related to TIS, TIB or TIC.

NOTE 5 If the requirements of 201.12.4.2b) are met, it is not required to enter any data in the column related to MI.

NOTE 6 The depths  $z_{pii}$  and  $z_{pii,\alpha}$  apply to NON-SCANNING MODES, while the depths  $z_{sii}$  and  $z_{sii,\alpha}$  apply to SCANNING MODES.

**Transducer Model: MC6-A**

**Operating Mode: B+C**

Index label			MI	TIS		TIB		TIC
				At surface	Below surface	At surface	Below surface	
Maximum index value			0.50	0.50		0.50		–
Index component value				0.50	0.50	0.44	0.50	
Acoustic Parameters	$p_{r,\alpha}$ at $Z_{MI}$	Mpa	1.11					
	P	mW		46.00		46.00		–
	$P_{1x1}$	mW		19.17		19.17		
	$Z_s$	cm			–			
	$Z_b$	cm					–	
	$Z_{MI}$	cm	2.44					
	$z_{pii,\alpha}$	cm	–					
	$f_{awf}$	MHz	5.89	5.89		5.89		–
Other Information	pr	Hz	–					
	sr	Hz	47.63					
	$n_{pps}$		1					
	$I_{pa,\alpha}$ at $z_{pii,\alpha}$	W/cm <sup>2</sup>	–					
	$I_{spta,\alpha}$ at $z_{pii,\alpha}$ or $z_{sii,\alpha}$	mW/cm <sup>2</sup>	34.52					
	$I_{spta}$ at $z_{pii}$ or $z_{sii}$	mW/cm <sup>2</sup>	55.21					
	$p_r$ at $z_{pii}$	Mpa	–					
Operating Control Conditions	Focus	cm	4.00	4.00		4.00		–
	Power	%	100	100		100		–

NOTE 1 Only one operating condition per index.

NOTE 2 Data should be entered for “at surface” and “below surface” both in the columns related to

TIS or TIB.

NOTE 3 Information need not be provided regarding TIC for any TRANSDUCER ASSEMBLY not intended for transcranial or neonatal cephalic uses.

NOTE 4 If the requirements of 201.12.4.2a) are met, it is not required to enter any data in the columns related to TIS, TIB or TIC.

NOTE 5 If the requirements of 201.12.4.2b) are met, it is not required to enter any data in the column related to MI.

NOTE 6 The depths  $z_{pii}$  and  $z_{pii,\alpha}$  apply to NON-SCANNING MODES, while the depths  $z_{sii}$  and  $z_{sii,\alpha}$  apply to SCANNING MODES.

**Transducer Model: MC6-A**

**Operating Mode: PW**

Index label			MI	TIS		TIB		TIC
				At surface	Below surface	At surface	Below surface	
Maximum index value			0.20	0.90		0.80		—
Index component value				0.84	0.90	0.77	0.80	
Acoustic Parameter s	$p_{r,\alpha}$ at $Z_{MI}$	Mpa	0.49					
	P	mW		82.00		82.00		—
	$P_{1x1}$	mW		34.17		34.17		
	$Z_s$	cm			2.25			
	$Z_b$	cm					2.30	
	$Z_{MI}$	cm	0.01					
	$z_{pii,\alpha}$	cm	0.01					
	$f_{awf}$	MHz	5.23	5.23		5.23		—
Other Informatio n	pr	Hz	4000.0 0					
	srr	Hz	—					
	$n_{pps}$		1					
	$I_{pa,\alpha}$ at $z_{pii,\alpha}$	W/cm <sup>2</sup>	8.52					
	$I_{spta,\alpha}$ at $z_{pii,\alpha}$ or $z_{sii,\alpha}$	mW/cm <sup>2</sup>	10.23					
	$I_{spta}$ at $z_{pii}$ or $z_{sii}$	mW/cm <sup>2</sup>	33.21					
$p_r$ at $z_{pii}$	Mpa	0.57						
Operating Control Conditons	Focus	cm	5.00	5.00		5.00		—
	Power	%	100	100		100		—

NOTE 1 Only one operating condition per index.

NOTE 2 Data should be entered for “at surface” and “below surface” both in the columns related to

TIS or TIB.

NOTE 3 Information need not be provided regarding TIC for any TRANSDUCER ASSEMBLY not intended for transcranial or neonatal cephalic uses.

NOTE 4 If the requirements of 201.12.4.2a) are met, it is not required to enter any data in the columns related to TIS, TIB or TIC.

NOTE 5 If the requirements of 201.12.4.2b) are met, it is not required to enter any data in the column related to MI.

NOTE 6 The depths  $z_{pii}$  and  $z_{pii,\alpha}$  apply to NON-SCANNING MODES, while the depths  $z_{sii}$  and  $z_{sii,\alpha}$  apply to SCANNING MODES.

**Transducer Model: L7S-A**

**Operating Mode: B**

Index label			MI	TIS		TIB		TIC
				At surface	Below surface	At surface	Below surface	
Maximum index value			0.70	0.10		0.10		–
Index component value				0.10	0.10	0.07	0.10	
Acoustic Parameters	$p_{r,\alpha}$ at $Z_{MI}$	Mpa	1.92					
	P	mW		2.00		2.00		–
	$P_{1x1}$	mW		0.78		0.78		
	$Z_s$	cm			–			
	$Z_b$	cm					–	
	$Z_{MI}$	cm	1.44					
	$z_{pii,\alpha}$	cm	–					
	$f_{awf}$	MHz	7.72	8.16		8.16		–
Other Information	prr	Hz	–					
	srr	Hz	29.93					
	$n_{pps}$		1					
	$I_{pa,\alpha}$ at $z_{pii,\alpha}$	W/cm <sup>2</sup>	–					
	$I_{spta,\alpha}$ at $z_{pii,\alpha}$ or $z_{sii,\alpha}$	mW/cm <sup>2</sup>	65.42					
	$I_{spta}$ at $z_{pii}$ or $z_{sii}$	mW/cm <sup>2</sup>	83.26					
	$p_r$ at $z_{pii}$	Mpa	–					
Operating Control Conditions	Focus	cm	3.00	7.50		7.50		–
	Power	%	100	100		100		–

NOTE 1 Only one operating condition per index.

NOTE 2 Data should be entered for “at surface” and “below surface” both in the columns related to TIS or TIB.

NOTE 3 Information need not be provided regarding TIC for any TRANSDUCER ASSEMBLY not intended for transcranial or neonatal cephalic uses.

NOTE 4 If the requirements of 201.12.4.2a) are met, it is not required to enter any data in the columns related to TIS, TIB or TIC.

NOTE 5 If the requirements of 201.12.4.2b) are met, it is not required to enter any data in the column related to MI.

NOTE 6 The depths  $z_{pii}$  and  $z_{pii,\alpha}$  apply to NON-SCANNING MODES, while the depths  $z_{sii}$  and  $z_{sii,\alpha}$  apply to SCANNING MODES.

**Transducer Model:** L7S-A

**Operating Mode:** THI-B

Index label			MI	TIS		TIB		TIC
				At surface	Below surface	At surface	Below surface	
Maximum index value			0.40	0.10		0.10		–
Index component value				0.10	0.10	0.07	0.10	
Acoustic Parameters	$p_{r,\alpha}$ at $Z_{MI}$	Mpa	0.99					
	P	mW		12.00		12.00		–
	$P_{1x1}$	mW		4.69		4.69		
	$Z_s$	cm			–			
	$Z_b$	cm					–	
	$Z_{MI}$	cm	1.44					
	$z_{pii,\alpha}$	cm	–					
	$f_{awf}$	MHz	6.15	6.42		6.42		–
Other Information	prr	Hz	–					
	srr	Hz	29.93					
	$n_{pps}$		1					
	$I_{pa,\alpha}$ at $z_{pii,\alpha}$	W/cm <sup>2</sup>	–					
	$I_{spta,\alpha}$ at $z_{pii,\alpha}$ or $z_{sii,\alpha}$	mW/cm <sup>2</sup>	43.21					
	$I_{spta}$ at $z_{pii}$ or $z_{sii}$	mW/cm <sup>2</sup>	65.25					
$p_r$ at $z_{pii}$	Mpa	–						
Operating Control Conditions	Focus	cm	3.00	7.50		7.50		–
	Power	%	100	100		100		–

NOTE 1 Only one operating condition per index.

NOTE 2 Data should be entered for “at surface” and “below surface” both in the columns related to TIS or TIB.



NOTE 3 Information need not be provided regarding TIC for any TRANSDUCER ASSEMBLY not intended for transcranial or neonatal cephalic uses.

NOTE 4 If the requirements of 201.12.4.2a) are met, it is not required to enter any data in the columns related to TIS, TIB or TIC.

NOTE 5 If the requirements of 201.12.4.2b) are met, it is not required to enter any data in the column related to MI.

NOTE 6 The depths  $z_{pii}$  and  $z_{pii,\alpha}$  apply to NON-SCANNING MODES, while the depths  $z_{sii}$  and  $z_{sii,\alpha}$  apply to SCANNING MODES.

**Transducer Model:** L7S-A

**Operating Mode:** B+M

Index label			MI	TIS		TIB		TIC
				At surface	Below surface	At surface	Below surface	
Maximum index value			0.80	0.10		0.20		–
Index component value				0.08	0.10	0.16	0.20	
Acoustic Parameters	$p_{r,\alpha}$ at $Z_{MI}$	Mpa	1.92					
	P	mW		2.00		2.00		–
	$P_{1x1}$	mW		0.78		0.78		
	$Z_s$	cm			1.35			
	$Z_b$	cm					1.55	
	$Z_{MI}$	cm	1.44					
	$z_{pii,\alpha}$	cm	1.50					
	$f_{awf}$	MHz	6.66		8.01		6.66	
Other Information	pr	Hz	4717.00					
	srr	Hz	36.85					
	$n_{pps}$		1					
	$I_{pa,\alpha}$ at $z_{pii,\alpha}$	W/cm <sup>2</sup>	215.57					
	$I_{spta,\alpha}$ at $z_{pii,\alpha}$ or $z_{sii,\alpha}$	mW/cm <sup>2</sup>	213.33					
	$I_{spta}$ at $z_{pii}$ or $z_{sii}$	mW/cm <sup>2</sup>	235.64					
$p_r$ at $z_{pii}$	Mpa	2.72						
Operating Control Conditions	Focus	cm	6.50	0.50		6.50		–
	Power	%	100	100		100		–

NOTE 1 Only one operating condition per index.

NOTE 2 Data should be entered for “at surface” and “below surface” both in the columns related to

TIS or TIB.

NOTE 3 Information need not be provided regarding TIC for any TRANSDUCER ASSEMBLY not intended for transcranial or neonatal cephalic uses.

NOTE 4 If the requirements of 201.12.4.2a) are met, it is not required to enter any data in the columns related to TIS, TIB or TIC.

NOTE 5 If the requirements of 201.12.4.2b) are met, it is not required to enter any data in the column related to MI.

NOTE 6 The depths  $z_{pii}$  and  $z_{pii,\alpha}$  apply to NON-SCANNING MODES, while the depths  $z_{sii}$  and  $z_{sii,\alpha}$  apply to SCANNING MODES.

**Transducer Model:** L7S-A

**Operating Mode:** THI-B+M

Index label			MI	TIS		TIB		TIC
				At surface	Below surface	At surface	Below surface	
Maximum index value			0.70	0.10		0.20		–
Index component value				0.08	0.10	0.18	0.20	
Acoustic Parameters	$p_{r,\alpha}$ at $Z_{MI}$	Mpa	1.81					
	P	mW		2.00		2.00		–
	$P_{1x1}$	mW		0.78		0.78		
	$Z_s$	cm			1.45			
	$Z_b$	cm					1.55	
	$Z_{MI}$	cm	1.44					
	$z_{pii,\alpha}$	cm	1.50					
	$f_{awf}$	MHz	6.63		7.92		6.68	
Other Information	prr	Hz	4717.00					
	srr	Hz	36.85					
	$n_{pps}$		1					
	$I_{pa,\alpha}$ at $z_{pii,\alpha}$	W/cm <sup>2</sup>	215.32					
	$I_{spta,\alpha}$ at $z_{pii,\alpha}$ or $z_{sii,\alpha}$	mW/cm <sup>2</sup>	213.35					
	$I_{spta}$ at $z_{pii}$ or $z_{sii}$	mW/cm <sup>2</sup>	234.56					
$p_r$ at $z_{pii}$	Mpa	2.71						
Operating Control Conditions	Focus	cm	6.50	0.50		6.50		–
	Power	%	100	100		100		–

NOTE 1 Only one operating condition per index.

NOTE 2 Data should be entered for “at surface” and “below surface” both in the columns related to

TIS or TIB.

NOTE 3 Information need not be provided regarding TIC for any TRANSDUCER ASSEMBLY not intended for transcranial or neonatal cephalic uses.

NOTE 4 If the requirements of 201.12.4.2a) are met, it is not required to enter any data in the columns related to TIS, TIB or TIC.

NOTE 5 If the requirements of 201.12.4.2b) are met, it is not required to enter any data in the column related to MI.

NOTE 6 The depths  $z_{pii}$  and  $z_{pii,\alpha}$  apply to NON-SCANNING MODES, while the depths  $z_{sii}$  and  $z_{sii,\alpha}$  apply to SCANNING MODES.

**Transducer Model:** L7S-A

**Operating Mode:** B+C

Index label			MI	TIS		TIB		TIC
				At surface	Below surface	At surface	Below surface	
Maximum index value			0.70	0.10		0.10		–
Index component value				0.10	0.10	0.08	0.10	
Acoustic Parameters	$p_{r,\alpha}$ at $Z_{MI}$	Mpa	2.06					
	P	mW		32.00		32.00		–
	$P_{1x1}$	mW		12.50		12.50		
	$Z_s$	cm			–			
	$Z_b$	cm					–	
	$Z_{MI}$	cm	1.44					
	$z_{pii,\alpha}$	cm	–					
	$f_{awf}$	MHz	7.99	8.28		8.28		–
Other Information	$p_{rr}$	Hz	–					
	$s_{rr}$	Hz	26.76					
	$n_{pps}$			1				
	$I_{pa,\alpha}$ at $z_{pii,\alpha}$	W/cm <sup>2</sup>	–					
	$I_{spta,\alpha}$ at $z_{pii,\alpha}$ or $z_{sii,\alpha}$	mW/cm <sup>2</sup>	183.20					
	$I_{spta}$ at $z_{pii}$ or $z_{sii}$	mW/cm <sup>2</sup>	200.26					
	$p_r$ at $z_{pii}$	Mpa	–					
Operating Control Conditions	Focus	cm	5.50	2.50		2.50		–
	Power	%	100	100		100		–

NOTE 1 Only one operating condition per index.

NOTE 2 Data should be entered for “at surface” and “below surface” both in the columns related to TIS or TIB.

NOTE 3 Information need not be provided regarding TIC for any TRANSDUCER ASSEMBLY not intended for transcranial or neonatal cephalic uses.

NOTE 4 If the requirements of 201.12.4.2a) are met, it is not required to enter any data in the columns related to TIS, TIB or TIC.

NOTE 5 If the requirements of 201.12.4.2b) are met, it is not required to enter any data in the column related to MI.

NOTE 6 The depths  $z_{pii}$  and  $z_{pii,\alpha}$  apply to NON-SCANNING MODES, while the depths  $z_{sii}$  and  $z_{sii,\alpha}$  apply to SCANNING MODES.

Transducer Model: L7S-A

Operating Mode: PW

Index label			MI	TIS		TIB		TIC
				At surface	Below surface	At surface	Below surface	
Maximum index value			0.80	1.20		1.70		–
Index component value				1.10	1.20	1.60	1.70	
Acoustic Parameters	$p_{r,\alpha}$ at $Z_{MI}$	Mpa	2.26					
	P	mW		30.00		30.00		–
	$P_{1x1}$	mW		11.72		11.72		
	$Z_s$	cm			1.44			
	$Z_b$	cm					1.50	
	$Z_{MI}$	cm	1.46					
	$z_{pii,\alpha}$	cm	1.50					
	$f_{awf}$	MHz	7.95		8.15		7.97	
Other Information	pr	Hz	3424.70					
	srr	Hz	–					
	$n_{pps}$		1					
	$I_{pa,\alpha}$ at $z_{pii,\alpha}$	W/cm <sup>2</sup>	141.73					
	$I_{spta,\alpha}$ at $z_{pii,\alpha}$ or $z_{sii,\alpha}$	mW/cm <sup>2</sup>	142.23					
	$I_{spta}$ at $z_{pii}$ or $z_{sii}$	mW/cm <sup>2</sup>	160.35					
$p_r$ at $z_{pii}$	Mpa	3.05						
Operating Control Conditions	Focus	cm	5.50	2.50		4.50		–
	Power	%	100	100		100		–

NOTE 1 Only one operating condition per index.

NOTE 2 Data should be entered for “at surface” and “below surface” both in the columns related to

TIS or TIB.

NOTE 3 Information need not be provided regarding TIC for any TRANSDUCER ASSEMBLY not intended for transcranial or neonatal cephalic uses.

NOTE 4 If the requirements of 201.12.4.2a) are met, it is not required to enter any data in the columns related to TIS, TIB or TIC.

NOTE 5 If the requirements of 201.12.4.2b) are met, it is not required to enter any data in the column related to MI.

NOTE 6 The depths  $z_{pii}$  and  $z_{pii,\alpha}$  apply to NON-SCANNING MODES, while the depths  $z_{sij}$  and  $z_{sij,\alpha}$  apply to SCANNING MODES.

## Appendix C: Guidance and Manufacturer’s Declaration

1. Guidance and manufacturer’s declaration – electromagnetic emissions		
The ECO 5 is intended for use in the electromagnetic environment specified below. The customer or the user of the ECO 5 should assure that it is used in such an environment.		
Emissions test	Compliance	Electromagnetic environment – guidance
RF emissions CISPR 11	Group 1	The ECO 5 uses RF energy only for its internal function. Therefore, its RF emissions are very low and are not likely to cause any interference in nearby electronic equipment.
RF emissions CISPR 11	Class A	The ECO 5 is suitable for use in medical establishments including domestic establishments and those directly connected to the public high-voltage power supply network that used for non-domestic purposes.
Harmonic emissions IEC 61000-3-2	Class A	
Voltage fluctuations/ flicker emissions IEC 61000-3-3	Complies	

2. Guidance and manufacturer’s declaration – electromagnetic immunity			
The ECO 5 is intended for use in the electromagnetic environment the ECO 5 should assure that it is used in such an environment.			
Immunity test	IEC 60601 test level	Compliance level	Electromagnetic environment – guidance

Electrostatic discharge (ESD) IEC 61000-4-2	±6 kV contact ±8 kV air	±6 kV contact ±8 kV air	Floors should be wood, concrete or ceramic tile. If floors are covered with synthetic material, the relative humidity should be at least 30 %.
Electrical fast transient/burst IEC 61000-4-4	±2 kV for power supply lines ±1 kV for input/output lines	±2 kV for power supply lines ±1 kV for input/output lines	Mains power quality should be that of a typical commercial or hospital environment.
Surge IEC 61000-4-5	±1 kV line(s) to line(s) ±2 kV line(s) to earth	±1 kV line(s) to line(s) ±2 kV line(s) to earth	Mains power quality should be that of a typical commercial or hospital environment.
interruptions and voltage variations on power supply input lines IEC 61000-4-11	<5 % UT (>95 % dip in UT) for 0,5 cycle 40 % UT (60 % dip in UT) for 5 cycles 70 % UT (30 % dip in UT) for 25 cycles <5 % UT (>95 % dip in UT) for 5 sec	<5 % UT (>95 % dip in UT) for 0,5 cycle 40 % UT (60 % dip in UT) for 5 cycles 70 % UT (30 % dip in UT) for 25 cycles <5 % UT (>95 % dip in UT) for 5 sec	Mains power quality should be that of a typical commercial or hospital environment. If the user of the ECO 5 requires continued operation during power mains interruptions, it is recommended that the ECO 5 be powered from an uninterruptible power supply or a battery.
Power frequency magnetic field (50-60 Hz) IEC 61000-4-8	3 A/m	3 A/m	Power frequency magnetic fields should be at levels characteristic of a typical location in a typical commercial or hospital environment.
NOTE UT is the a.c. mains voltage prior to application of the test level.			

3 Guidance and manufacturer's declaration – electromagnetic immunity			
The ECO 5 is intended for use in the electromagnetic environment specified below. The customer or the user of the ECO 5 should assure that it is used in such an environment.			
3.1. Immunity test	IEC 60601 test level	IEC 60601 test level	Electromagnetic environment – guidance

<p>Conducted RF IEC 61000-4-6 Radiated RF IEC 61000-4-3</p>	<p>3 Vrms 150 kHz to 80 MHz 3 V/m 80 MHz to 2,5 GHz</p>	<p>3 Vrms 3 V/m</p>	<p>Portable and mobile RF communications equipment should be used no closer to any part of the ECO 5, including cables, than the recommended separation distance calculated from the equation applicable to the frequency of the transmitter.</p> <p>Recommended separation distance</p> $d = 1,2 \sqrt{P}$ $d = 1,2 \sqrt{P} \quad 80 \text{ MHz to } 800 \text{ MHz}$ $d = 2,3 \sqrt{P} \quad 800 \text{ MHz to } 2,5 \text{ GHz}$ <p>where <math>P</math> is the maximum output power rating of the transmitter in watts (W) according to the transmitter manufacturer and <math>d</math> is the recommended separation distance in metres (m)</p> <p>Field strengths from fixed RF transmitters, as determined by an electromagnetic site survey, should be less than the compliance level in each frequency range.<sup>b</sup></p> <p>Interference may occur in the vicinity of equipment marked with the following symbol:</p> 
---	---	-------------------------	--

NOTE 1 At 80 MHz and 800 MHz, the higher frequency range applies.

NOTE 2 These guidelines may not apply in all situations. Electromagnetic propagation is affected by absorption and reflection from structures, objects and people.

a Field strengths from fixed transmitters, such as base stations for radio (cellular/cordless) telephones and land mobile radios, amateur radio, AM and FM radio broadcast and TV broadcast cannot be predicted theoretically with accuracy. To assess the electromagnetic environment due to fixed RF transmitters, an electromagnetic site survey should be considered. If the measured field strength in the location in which the ECO 5 is used exceeds the applicable RF compliance level above, the ECO 5 should be observed to verify normal operation. If abnormal performance is observed, additional measures may be necessary, such as reorienting or relocating the ECO 5.

b Over the frequency range 150 kHz to 80 MHz, field strengths should be less than 3 V/m.

Recommended separation distances between portable and mobile RF communications equipment and the ECO 5

The ECO 5 is intended for use in an electromagnetic environment in which radiated RF disturbances are controlled. The customer or the user of the ECO 5 can help prevent electromagnetic interference by maintaining a minimum distance between portable and mobile RF communications equipment (transmitters) and the ECO 5 as recommended below, according to the maximum output power of the communications equipment.

Rated maximum output power of transmitter W	Separation distance according to frequency of transmitter m		
	150 kHz to 80 MHz $d = 1,2 \sqrt{P}$	80 MHz to 800 MHz $d = 1,2 \sqrt{P}$	800 MHz to 2,5 GHz $d = 2,3 \sqrt{P}$
0,01	0,12	0,12	0,23
0,1	0,38	0,38	0,73
1	1,2	1,2	2,3
10	3,8	3,8	7,3
100	12	12	23

For transmitters rated at a maximum output power not listed above, the recommended separation distance  $d$  in meters (m) can be estimated using the equation applicable to the frequency of the transmitter, where  $P$  is the maximum output power rating of the transmitter in watts (W) according to the transmitter manufacturer.

NOTE 1 At 80 MHz and 800 MHz, the separation distance for the higher frequency range applies.

NOTE 2 These guidelines may not apply in all situations. Electromagnetic propagation is affected by absorption and reflection from structures, objects and people.



## Appendix D: Measurement Results Summary

Measurement	Useful Range	Accuracy
Distance	Full Screen	<±5%
Circumference: trace method, ellipse method	Full Screen	<±5%
Area: trace method, ellipse method	Full Screen	<±10%
Volume	Full screen	<±10%
Angle	Full screen	<±5%
Time	Full Screen	<±5%
Heart rate	Full Screen	<±5%
Velocity	Full Screen	<±10%

## Appendix E: Display Accuracy and Acoustic Measurement Uncertainties

According to IEC60601-2-37 and NEMA UD-3 2004, the display accuracy and acoustic measurement uncertainties are summarized in the table below.

Display accuracy of MI is  $\pm 20\%$ , and TI is  $\pm 40\%$  or  $< 0.1$ , if MI, TI below 0.5.

Item	Measurement Uncertainty (Percentage, 95% Confidence Value)
Center Frequency	$\pm 15\%$
Acoustic Power	$\pm 30\%$
Acoustic Intensity	$\pm 30\%$
Peak Rarefactional Pressure	$\pm 15\%$

## Appendix F: Transducer Maximum Surface Temperature

According to the requirements of the section 201.11 in the standard IEC60601-2-37:2007/AMD1:2015, the transducer surface temperature has been tested in two kinds of conditions: the transducer suspended in still air or transducer contacting human-tissue mimicking material. The calculation of the expanded uncertainty is based on the ISO Guide tout ye Expression of uncertainty in measurement. Three transducer samples have been tested and the confidence coefficient is at 95%,the value of t.975 is 4.30.

The measurement data were obtained under the test conditions employed at CHISON.

<b>Transducer model</b>	<b>Maximum surface temperature(°C)</b>
<b>C3-A</b>	<b>&lt;41.0</b>
<b>MC6-A</b>	<b>&lt;41.0</b>
<b>L7M-A</b>	<b>&lt;41.0</b>
<b>R7-A</b>	<b>&lt;41.0</b>
<b>L7S-A</b>	<b>&lt;41.0</b>
<b>MC3-A</b>	<b>&lt;41.0</b>
<b>V6-A</b>	<b>&lt;41.0</b>

## Appendix G: Procedures of setting network sharing

### For Windows set up, set up a shared document

1. Choose the file you want to share, as the “test” file.

Name	Date modified	Type	Size
7208_1754125_MVM_10.tmp	2015/5/13 18:36	TMP File	0 KB
7208_1754125_MVM_7.tmp	2015/5/13 18:36	TMP File	0 KB
4388_1485765_MVM_10.tmp	2015/5/18 4:27	TMP File	0 KB
4388_1485765_MVM_7.tmp	2015/5/18 4:27	TMP File	0 KB
System Volume Information	2014/12/1 20:41	File folder	
test	2015/5/20 19:28	File folder	

2. Right click this file, choose “properties”, and click “share”.

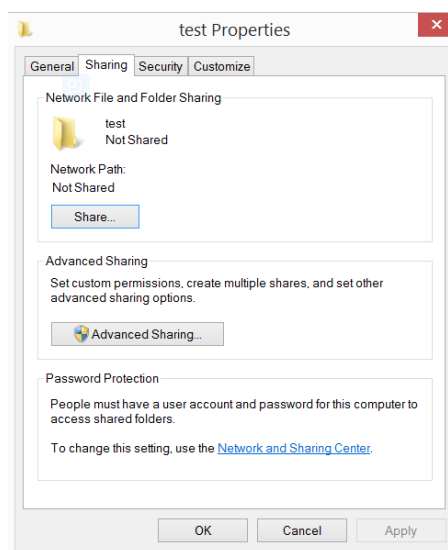

3. Then you can see the sharing setting interface, as you can see in the picture, choose “everyone”, and click “add”.

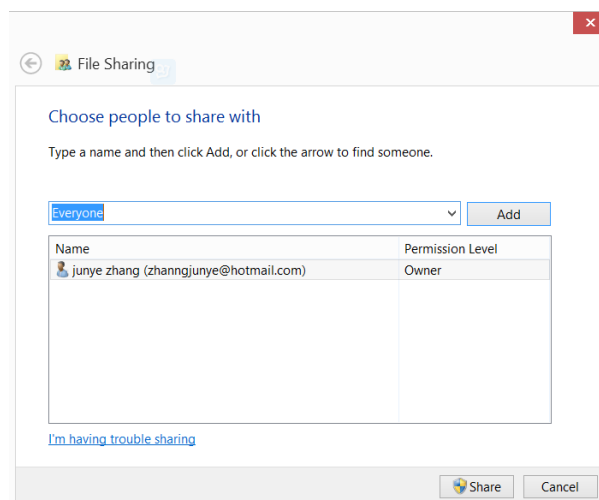

4. Choose “read/write” in the permission level in everyone, then click “share”, after that, confirm.

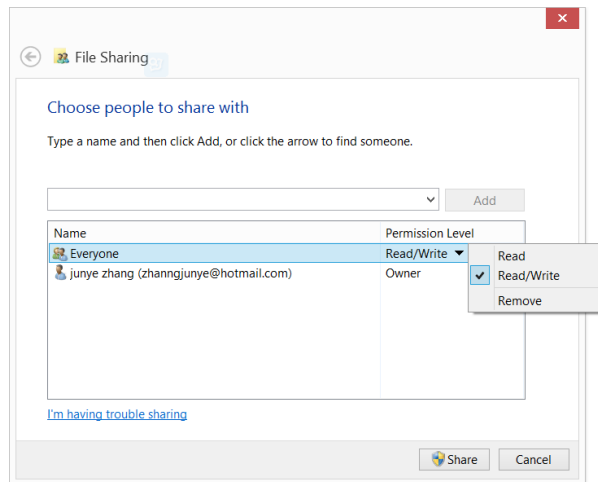

5. If the windows have not set the code, then turn off the password protected sharing is necessary. instructions as the image shows.

a) Click “network and sharing center” in the sharing properties.

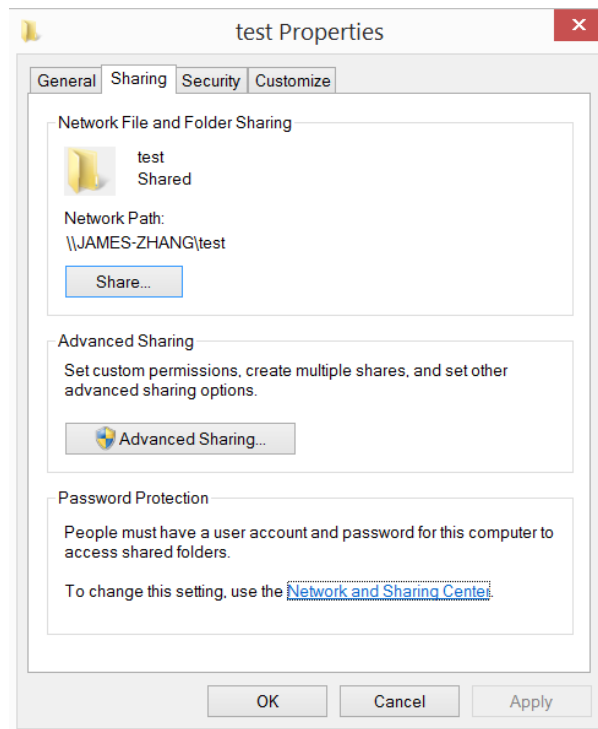

b) In the network and sharing center interface, choose “public”, in the password protected sharing, choose turn off password protected sharing.

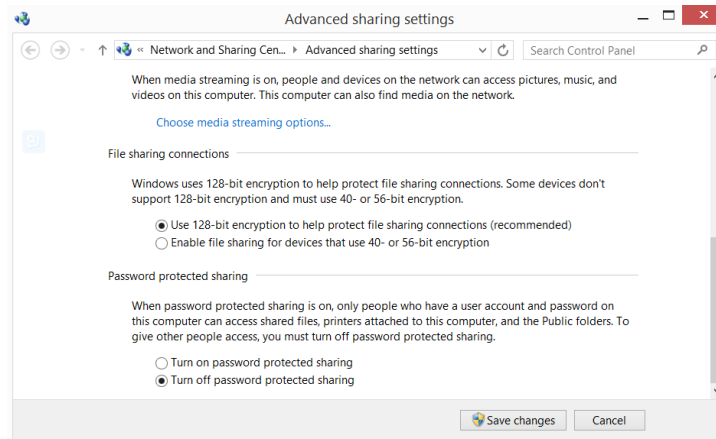

## Set up in system

### IP set up

1. First, confirm the service address of shared files, you can get the IP address in windows interface.

In windows “start”-“run” type in “cmd” and enter, then type in “ ipconfig” and enter, you can see the IP address of local service.

```

Connection-specific DNS Suffix . . : 
Link-local IPv6 Address . . . . . : fe80::d91e:e058:f895:336d%3
IPv4 Address. . . . . : 192.168.1.131
Subnet Mask . . . . . : 255.255.255.0
Default Gateway . . . . . : 192.168.1.1

```

2. Enter into set up interface, choose net. Choose “DHCP”(automatically get the IP address)or “static”(type in IP address manually);

**⚠️ Tips:** if you want to type in IP address manually, make sure the IP address is in the same internet section with the service, and won't confused with other IP in the LAN.

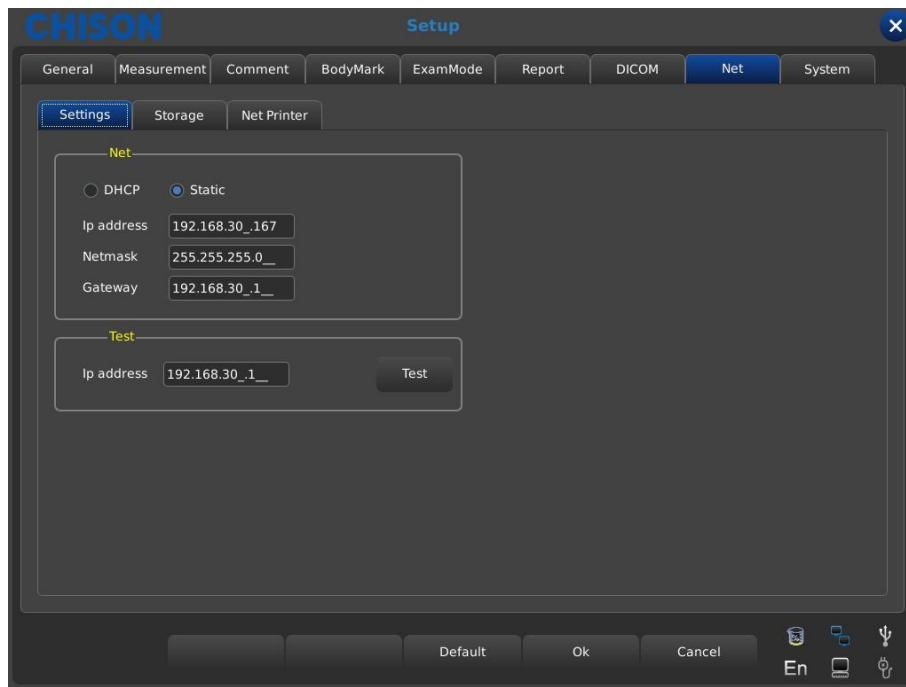

3. Choose net “storage” interface, type in service name, IP address, user name, password and the name of shared files, click “add” to add a network storage, you can choose the export route. As shown in the picture.

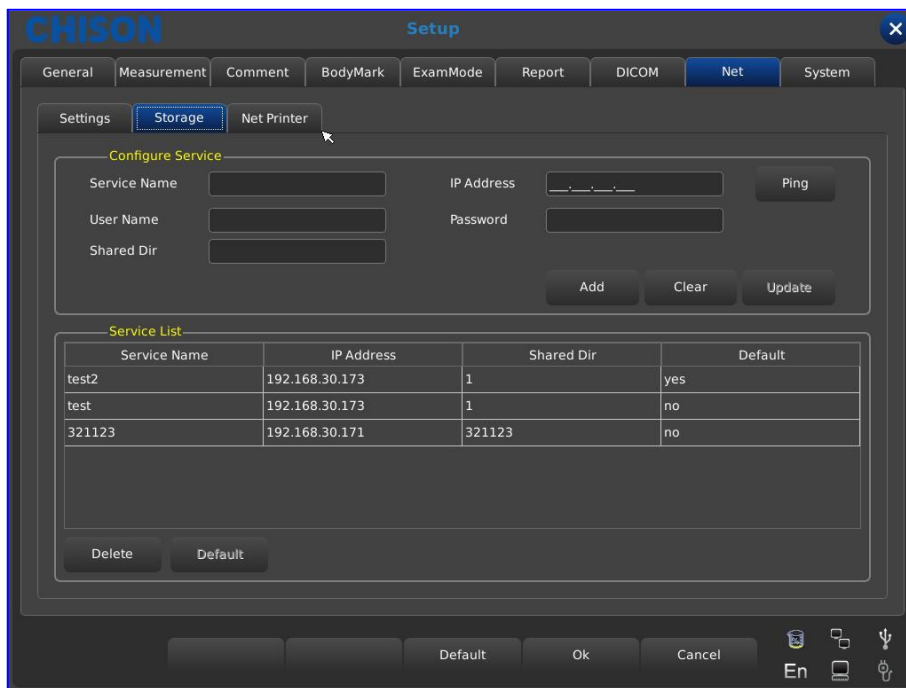

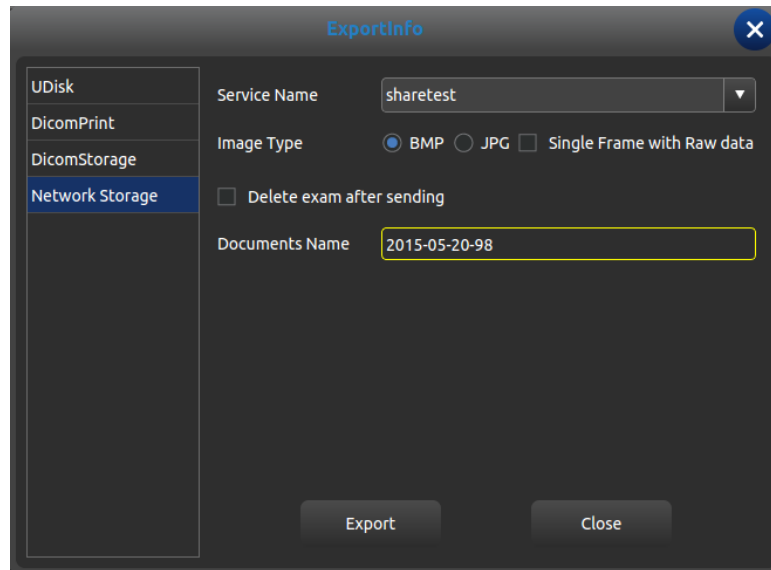

**Ping:** test if the IP is connected or not.

**Clear:** clear all the IP address, user name, password and names of shared file

**Update:** update the content to the chosen item.

**Delete:** delete the chosen service item.

**Default:** set the chosen item as the default net route.

**⚠ NOTE:** you can add multi-numbers of network storage service to realize the transmission among multi systems.

**⚠ NOTE:** if windows turns off password protected sharing, then in set up, you can type in user name and password arbitrarily.

## Net Printer Setup

1. Press **[Setup]** key to enter into the Setup interface, then select Net and Net Printer.



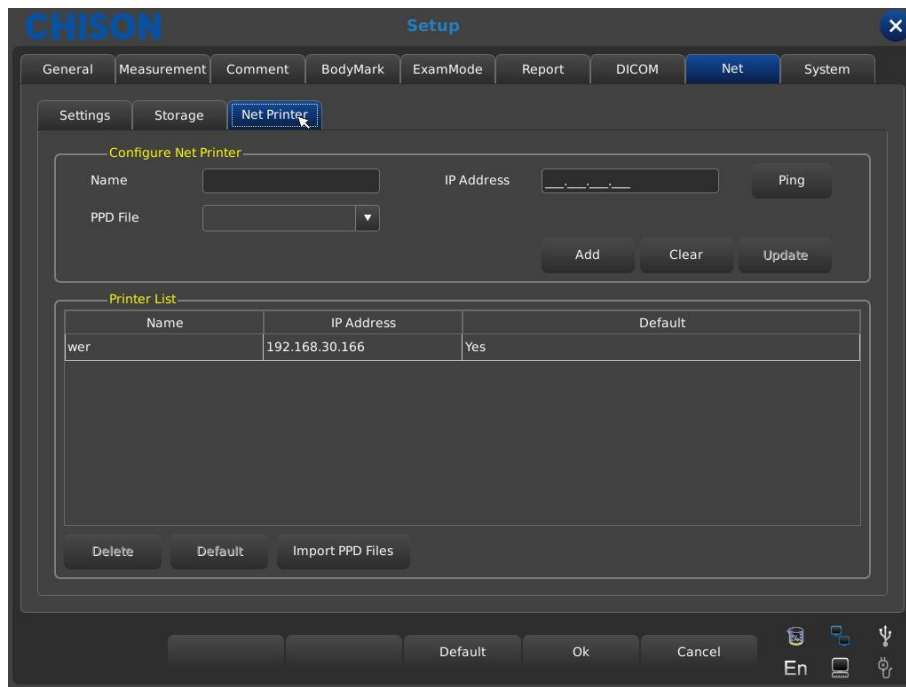

## 2. Configure Net Printer

Operation:

- Input name and IP Address which has installed printer equipment.
- Choose **[Ping]** to confirm whether the net connect normally.
- Select PPD File and press **[Add]**, the net connecting information can be saved on the Printer

List.

- Choose the information on the Printer List to finish the printing according to the requirement.

# CHISON



**CHISON Medical Technologies Co., Ltd.**

---

No.3 Changjiang South Road, Xinwu District, Wuxi, 214028 Jiangsu, P.R. China